

Download the Arduino IDE (Integrated Development Environment)



Access the Internet

In order to get your Arduino up and running, you'll need to download some software first from www.arduino.cc (it's free!). This software, known as the Arduino IDE, will allow you to program the Arduino to do exactly what you want. It's like a word processor for writing programs. With an internet-capable computer, open up your favorite browser and type in the following URL into the address bar:



arduino.cc/en/Main/Software

< case sensitive >

1

Download

Click on the “+” sign next to your appropriate computer operating system.

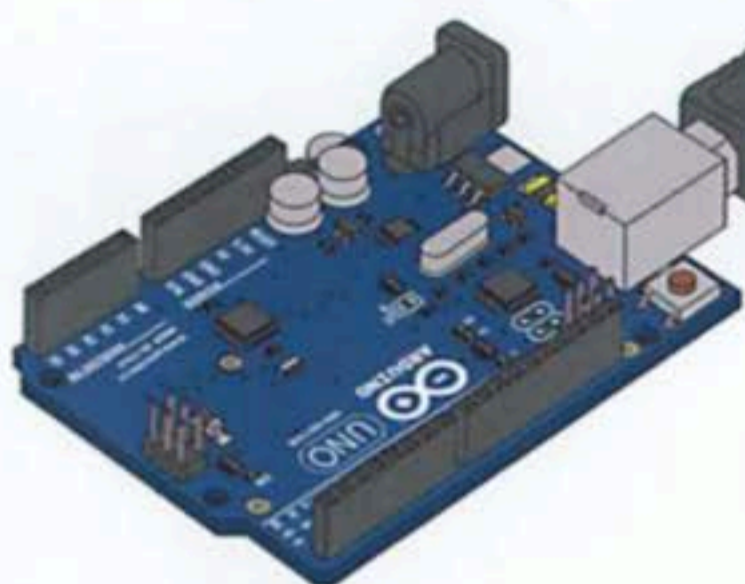
- + Windows
- + Mac OS X
- + Linux: 32 bit, 64 bit
- + source



Choose the appropriate Operating System installation package for your computer.

// Connect your Arduino Uno to your Computer

Use the USB cable provided in the USK kit to connect the Arduino to one of your computer's USB inputs.



2

3

// Install Drivers

Depending on your computer's operating system, you will need to follow specific instructions. Please consult the URLs below for specific instructions on how to install the drivers onto your Arduino Uno.

* You will need to scroll to the section labeled "Install the drivers".



Windows Installation Process

Go to the web address below to access the instructions for installations on a Windows-based computer.

<http://arduino.cc/en/Guide/Windows>



Macintosh OS X Installation Process

Macs do not require you to install drivers. Enter the following URL if you have questions. Otherwise proceed to next page.

<http://arduino.cc/en/Guide/MacOSX>



Linux: 32 bit / 64 bit, Installation Process

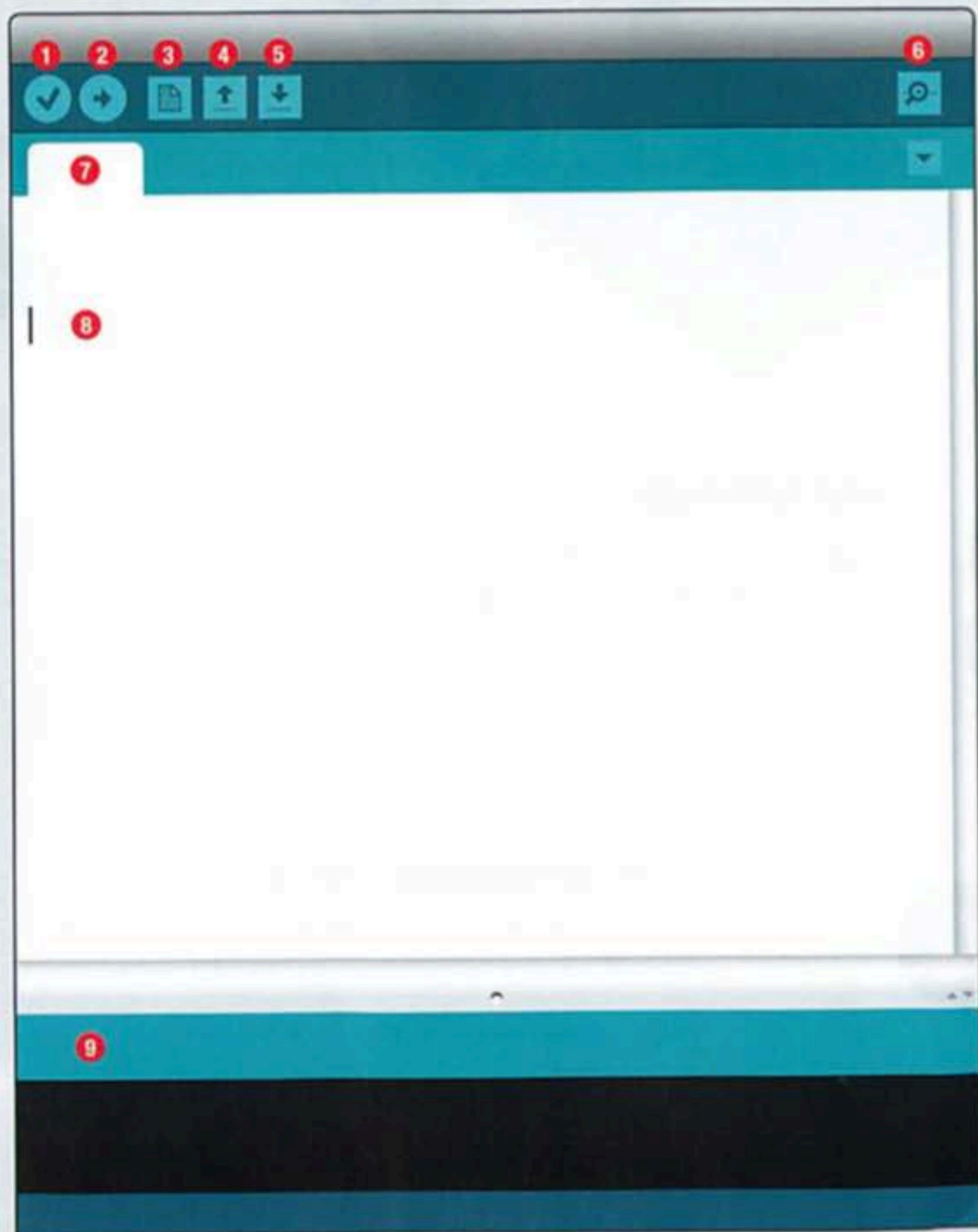
Go to the web address below to access the instructions for installations on a Linux-based computer.

<http://www.arduino.cc/playground/Learning/Linux>



// Open the Arduino IDE:

Open the Arduino IDE software on your computer. Poke around and get to know the interface. We aren't going to code right away, this is just an introduction. The step is to set your IDE to identify your Arduino Uno.



GUI (Graphical User Interface)

- 1 Verify:** Compiles and approves your code. It will catch errors in syntax (like missing semi-colons or parenthesis). // See Diagram Below
- 2 Upload:** Sends your code to the Arduino board. When you click it, you should see the lights on your board blink rapidly. // See Diagram Below
- 3 New:** This buttons opens up a new code window tab.
- 4 Open:** This button will let you open up an existing sketch. // See Diagram Below
- 5 Save:** This saves the currently active sketch.
- 6 Serial Monitor:** This will open a window that displays any serial information your Arduino is transmitting. It is very useful for debugging.
- 7 Sketch Name:** This shows the name of the sketch you are currently working on.
- 8 Code Area:** This is the area where you compose the code for your sketch.
- 9 Message Area:** This is where the IDE tells you if there were any errors in your code.

// The three most important commands for this guide are seen below:



Open



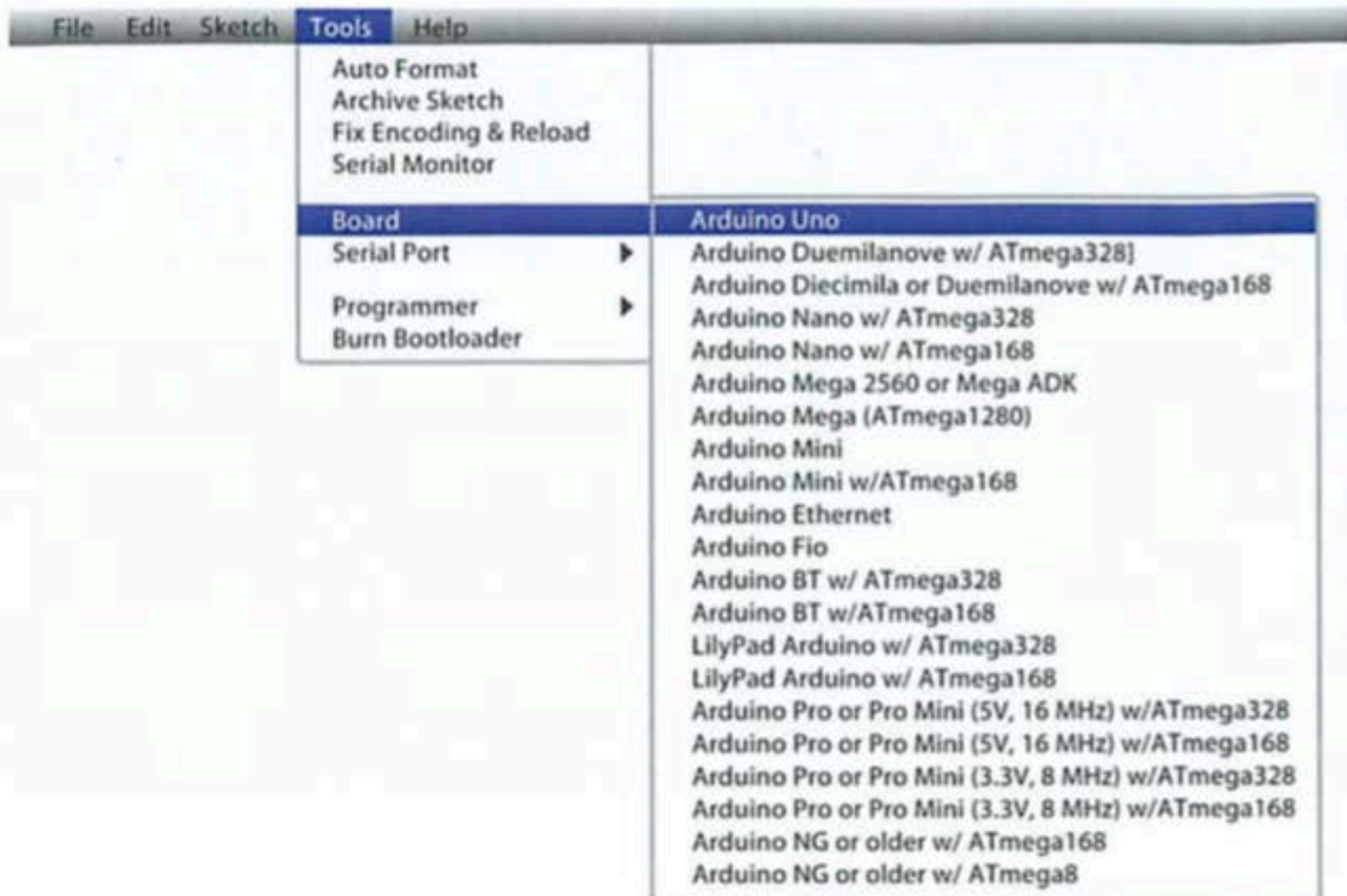
Verify



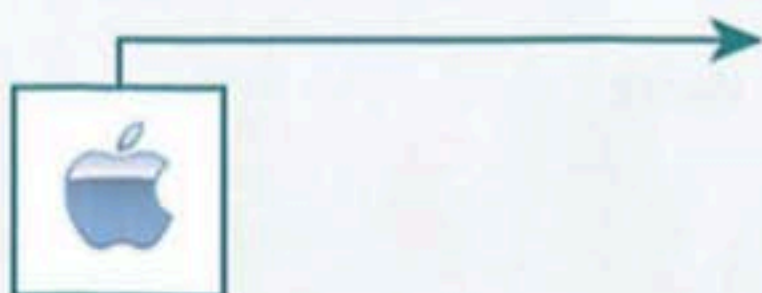
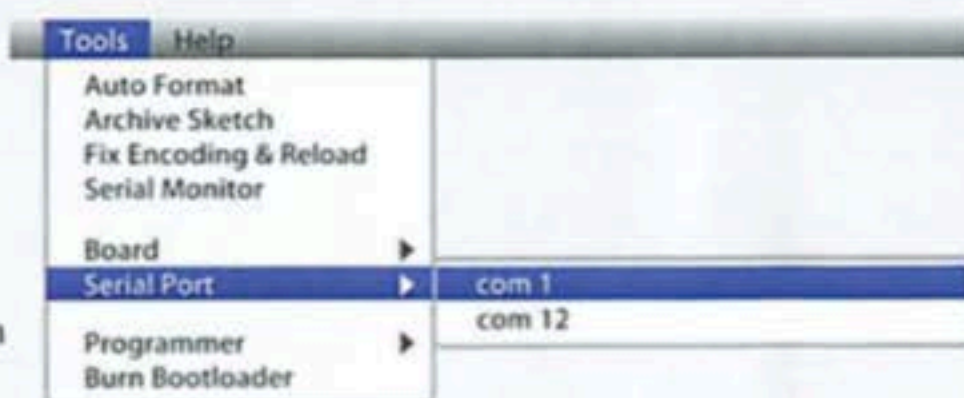
Upload

4

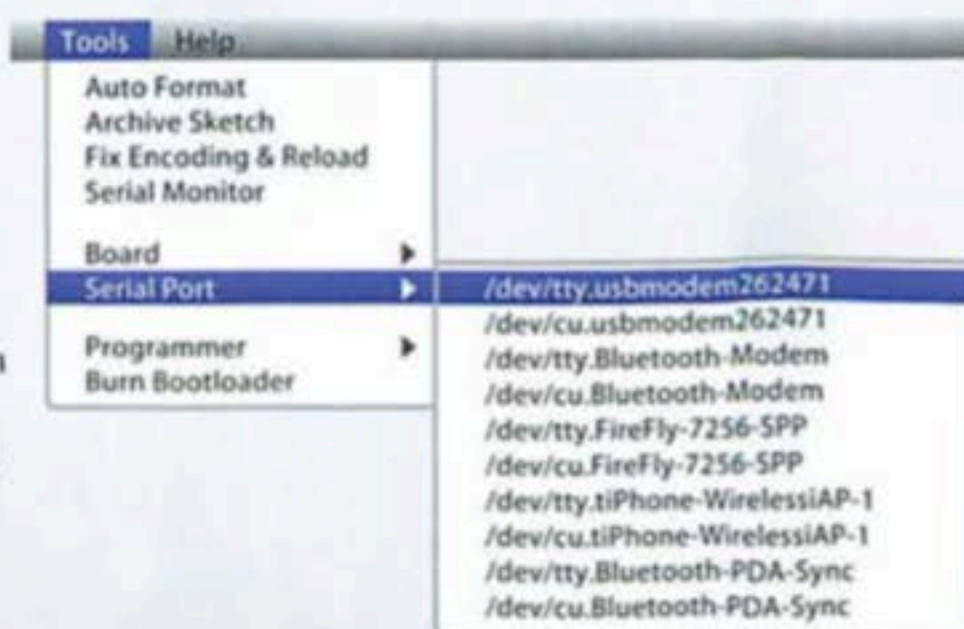
// Select your board: Arduino Uno



Select the serial device of the Arduino board from the Tools | Serial Port menu. This is likely to be **com3 or higher** (COM1 and COM2 are usually reserved for hardware serial ports). To find out, you can disconnect your Arduino board and re-open the menu; the entry that disappears should be the Arduino board. Reconnect the board and select that serial port.

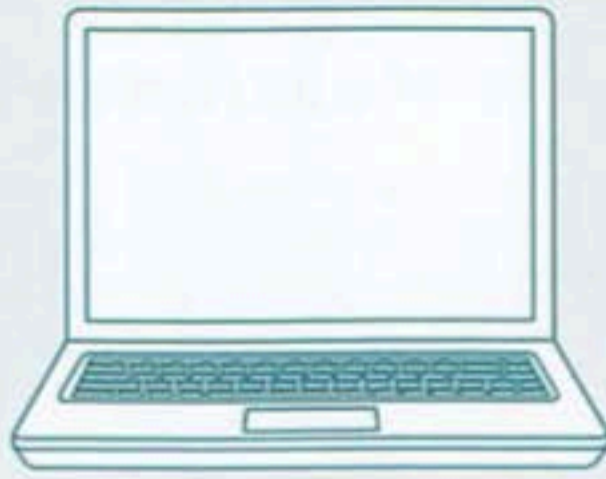


Select the serial device of the Arduino board from the Tools > Serial Port menu. On the Mac, this should be something with **/dev/tty.usbmodem** (for the Uno or Mega 2560) or **/dev/tty.usbserial** (for older boards) in it.



<http://www.arduino.cc/playground/Learning/Linux>

5



Type in the following **URL** to download the code:



// Copy "USK Guide Code" into "Examples" library in Arduino folder



Unzip the file "USK Guide Code". It should be located in your browser's "Downloads" folder. Right click the zipped folder and choose "unzip".



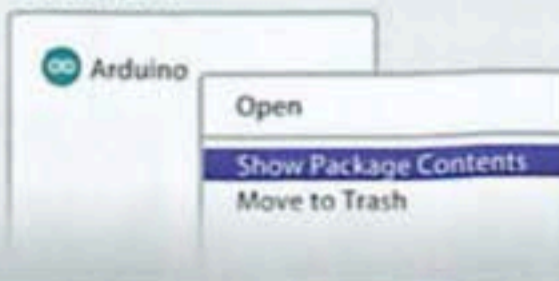
Copy the "USK Guide Code" folder into Arduino's folder named "examples".



Unzip the file "USK Guide Code". It should be located in your browser's "Downloads" folder. Right click the zipped folder and choose "unzip".



Find "Arduino" in your applications folder. Right click(ctrl + click) on "Arduino". Select "Show Package Contents".

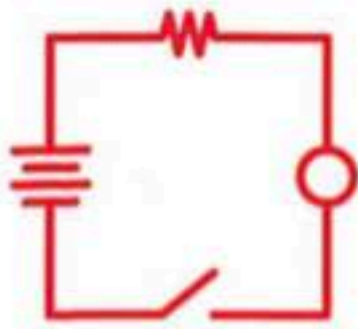


Copy the "USK Guide Code" folder into Arduino's folder named "examples".



<http://www.arduino.cc/playground/Learning/Linux>

Getting Started with Circuits



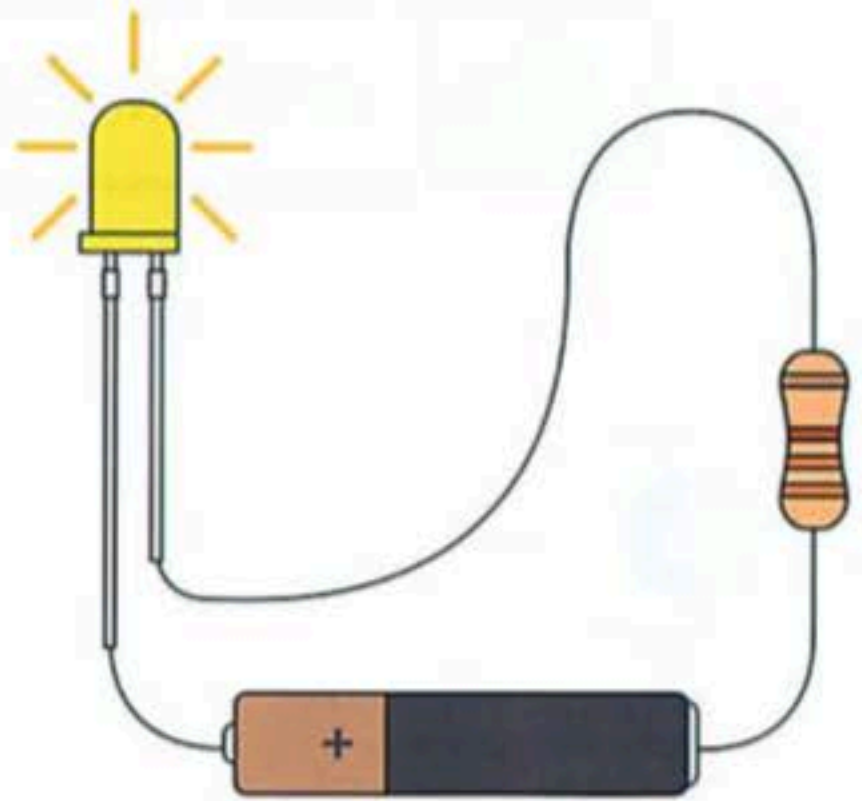
What is an Electrical Circuit?

A circuit is basically an electronics loop with a starting point and an ending point - with any number of components in between. Circuits can include resistors, diodes, inductors, sensors of all sizes and shapes, motors, and any other handful of hundreds of thousands of components.

Circuits are usually divided into three categories - analog circuits, digital circuits, or mixed-signal circuits. In this guide, you will explore all three sets of circuits.

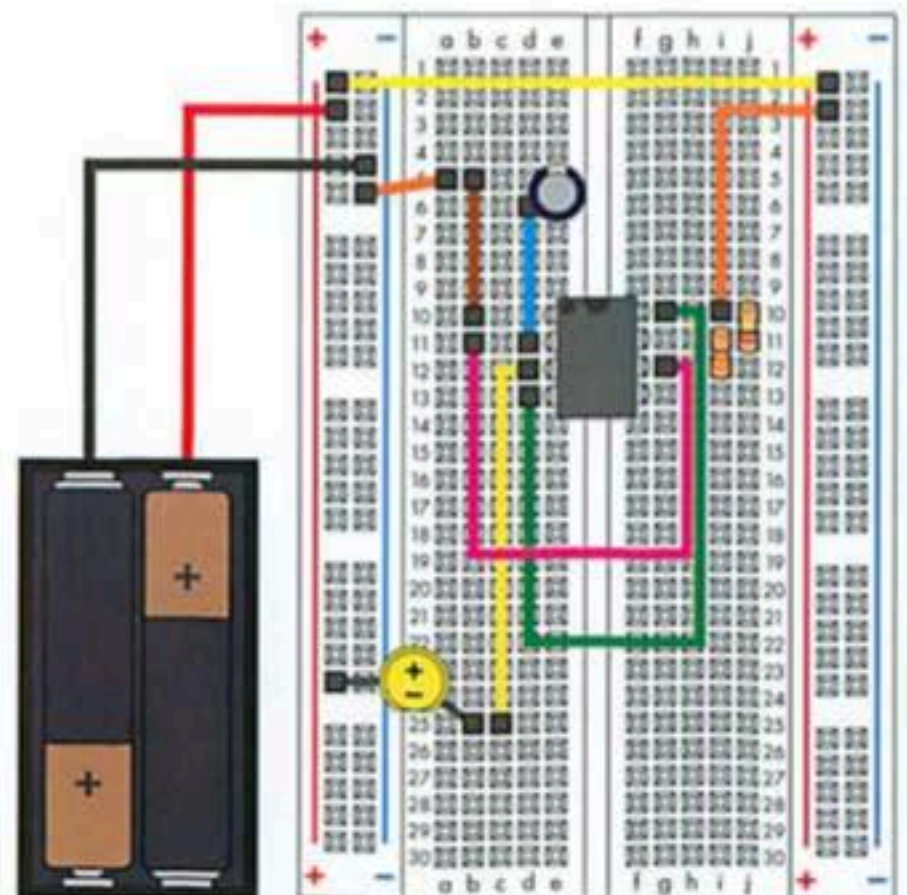
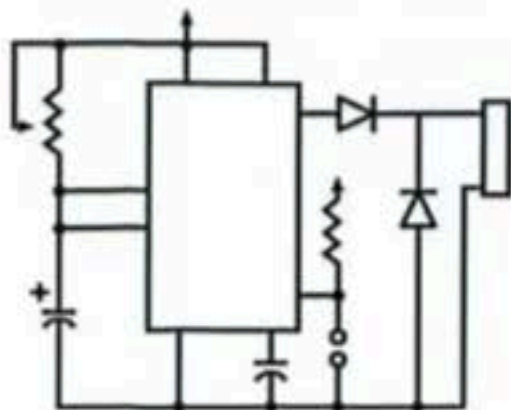
The World Runs on Circuits:

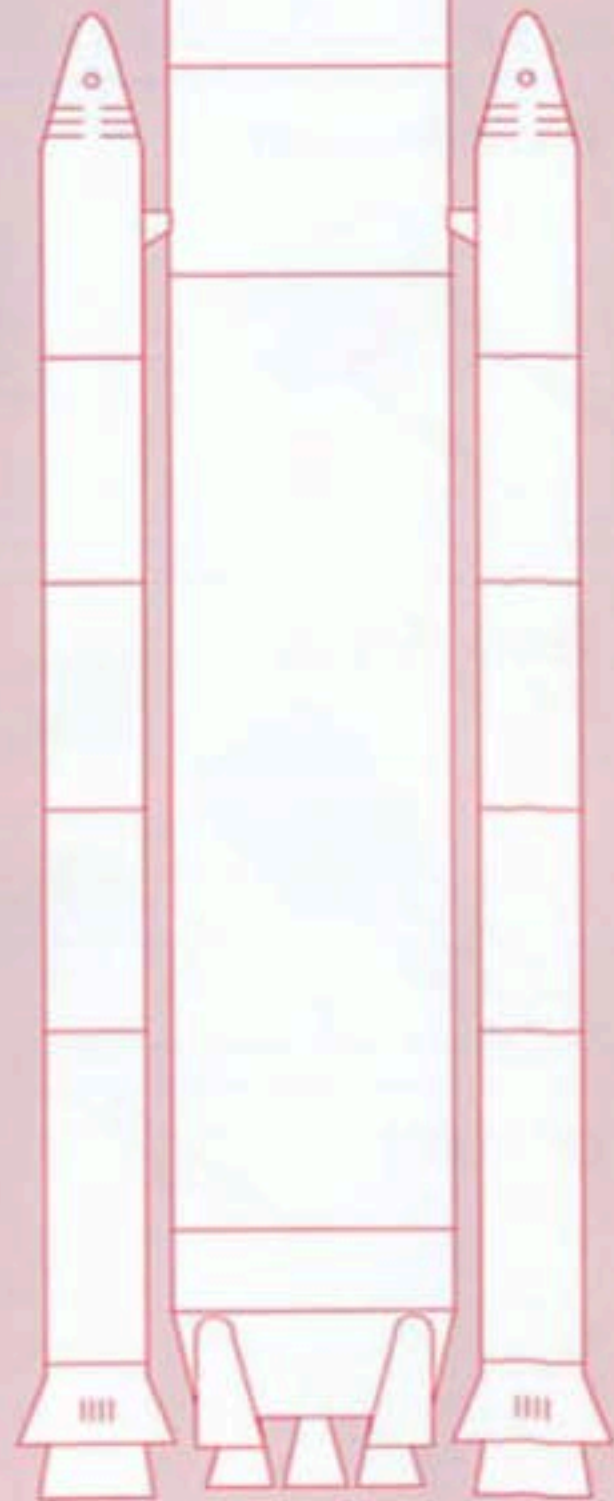
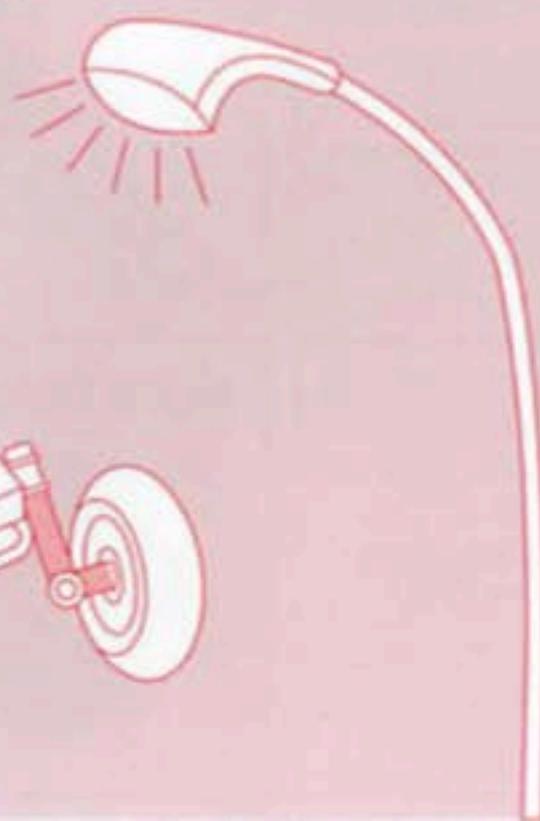
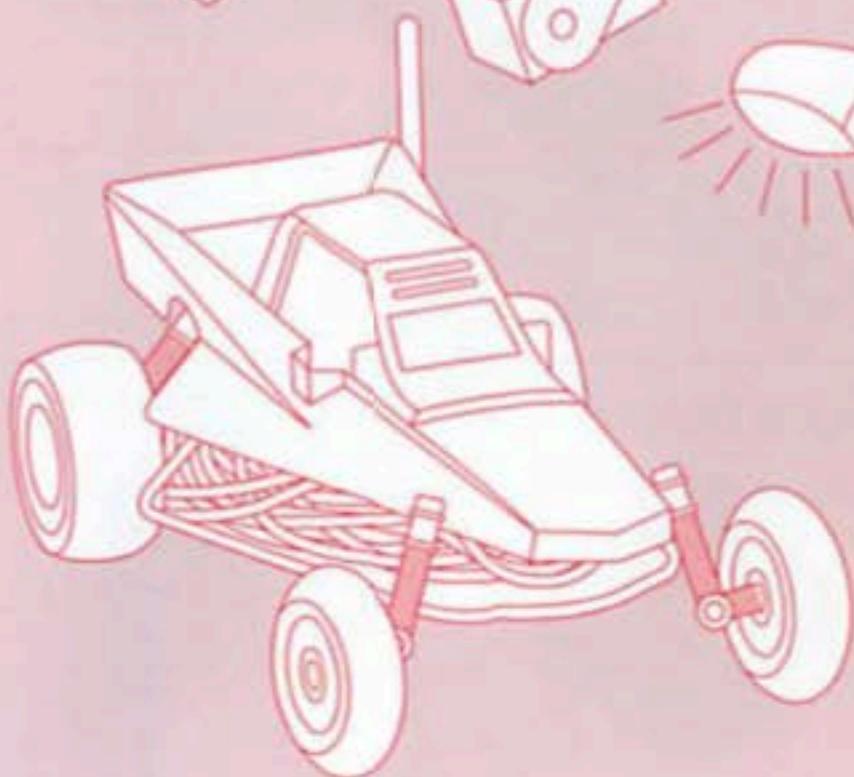
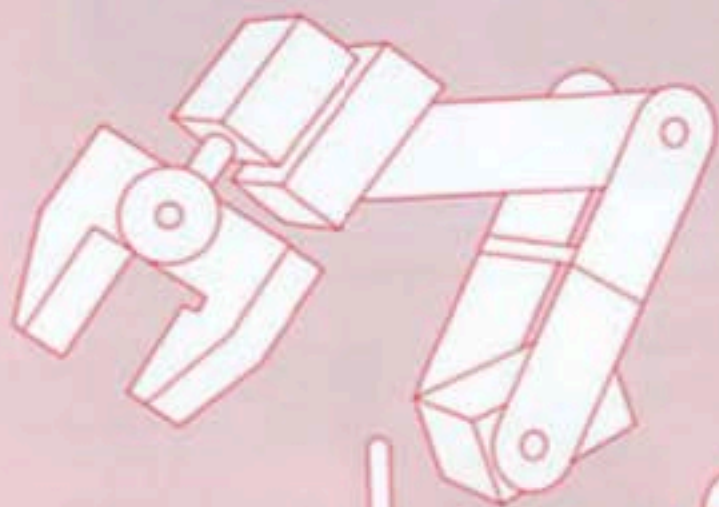
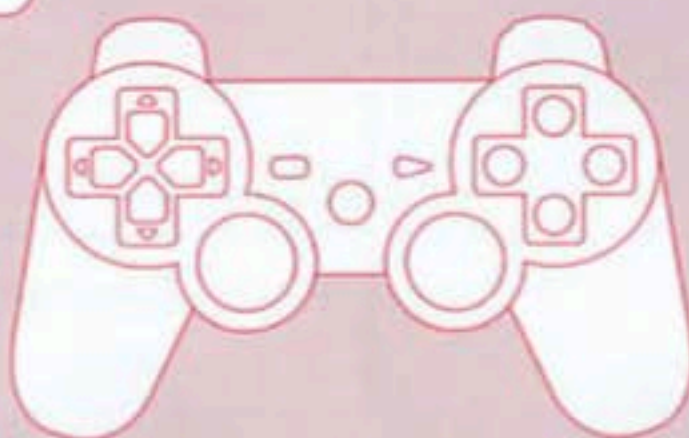
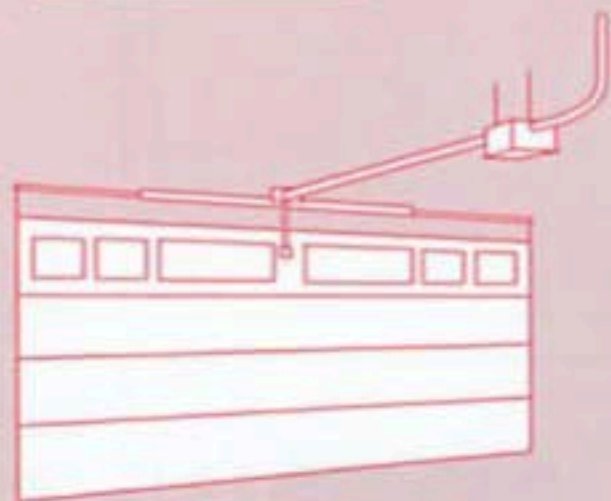
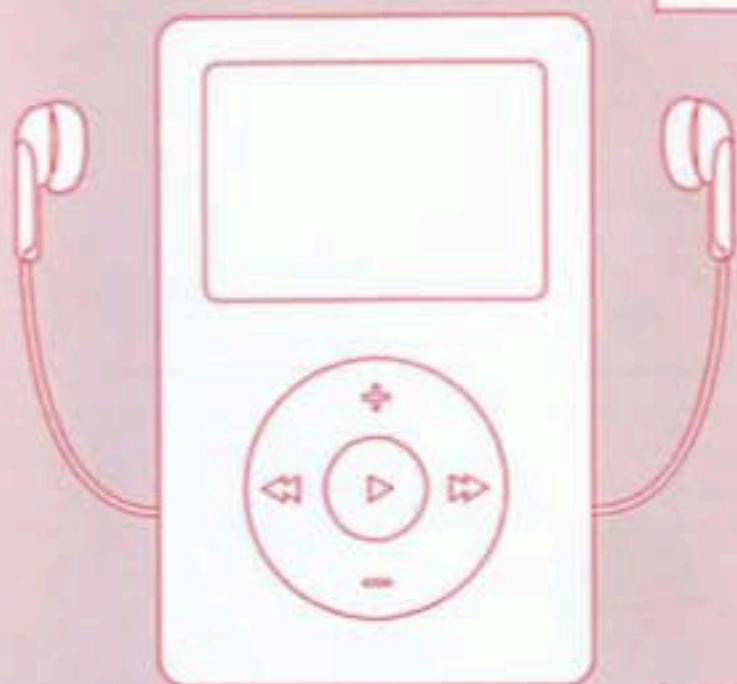
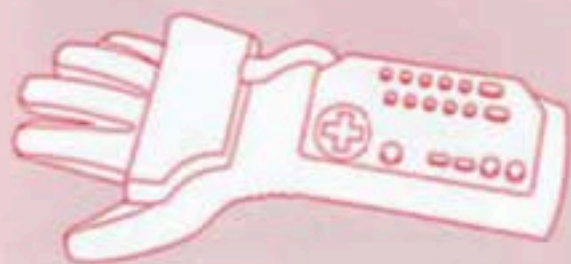
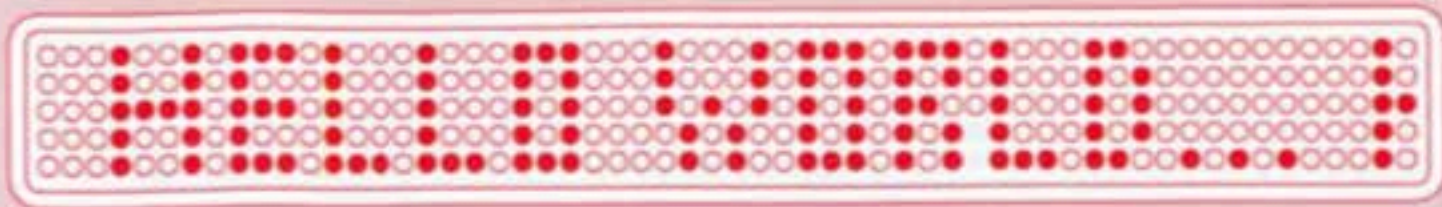
Everywhere you look, you'll find circuits. The cell phone in your pocket, the computer that controls your car's emissions system, your video game console - all these things are chock full of circuits. In this guide, you'll experiment with some simple circuits and learn the gist of the world of embedded electronics.



// Simple and Complex Circuits

In this guide, you will be primarily exploring simple circuits - but that doesn't mean you can't do amazing things with simple tools! When you've finished the USK, your knowledge of circuits will enable you to explore amazing projects and unleash the power of your imagination.





Inventory of Parts

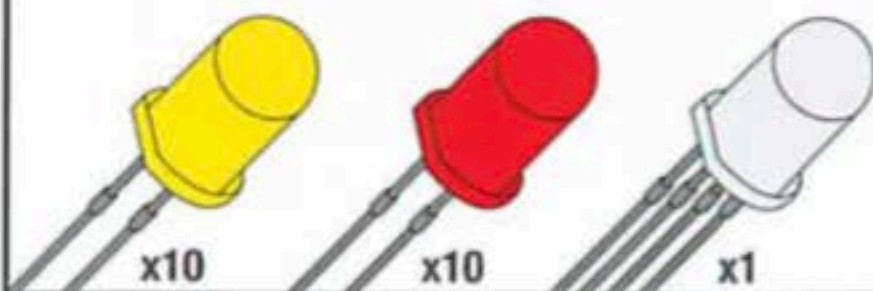
Jumper Wire
Various Colors



x30



LED (5mm)
(Light Emitting Diode)

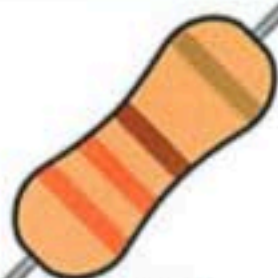


x10

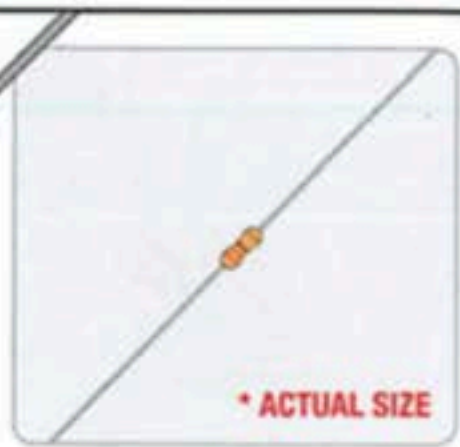
x10

x1

330Ω Resistor

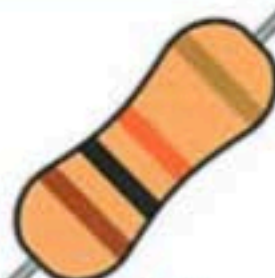


x25

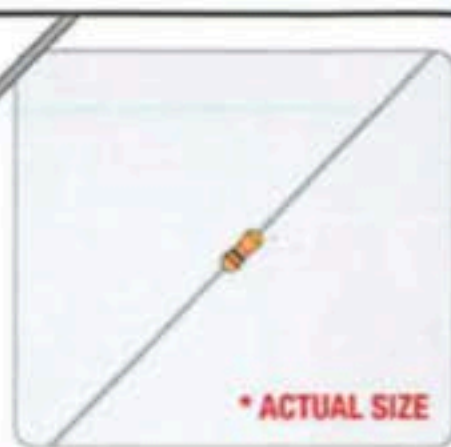


* ACTUAL SIZE

10KΩ Resistor

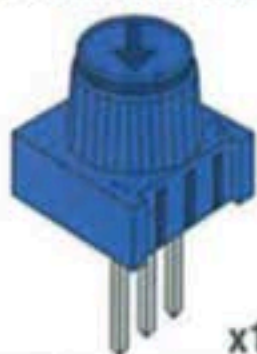


x25



* ACTUAL SIZE

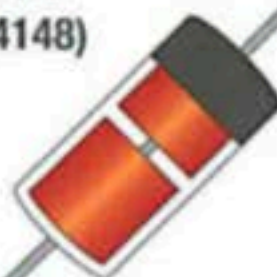
Potentiometer



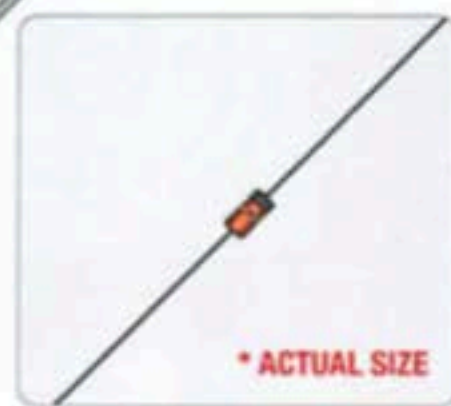
x1



Diode
(1N4148)

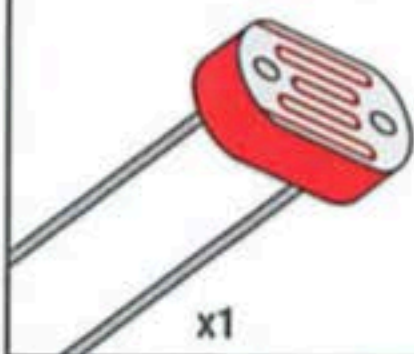


x2

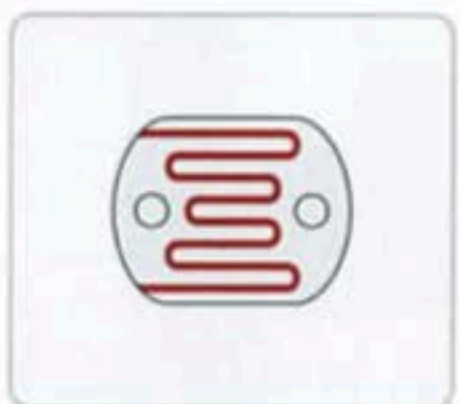


* ACTUAL SIZE

Photo Resistor



x1



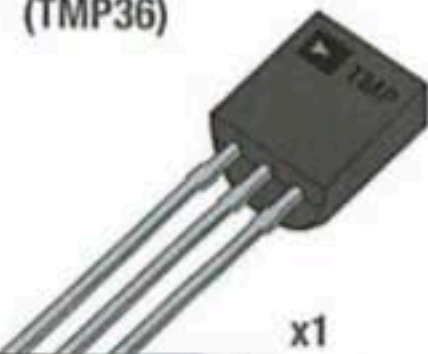
Piezo Element



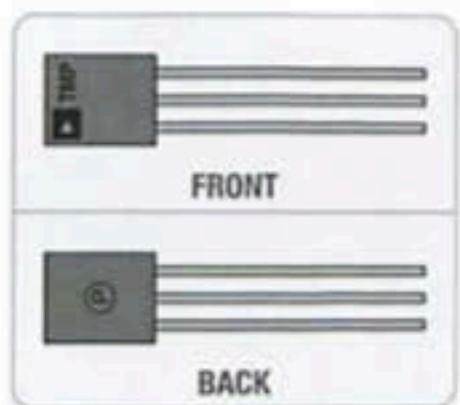
x1



Temp. Sensor
(TMP36)



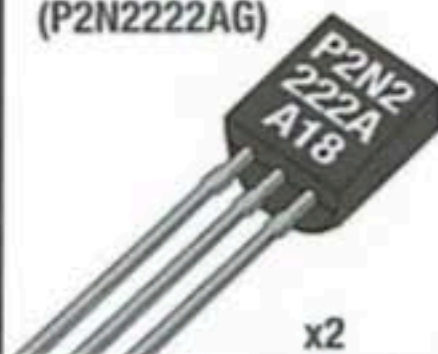
x1



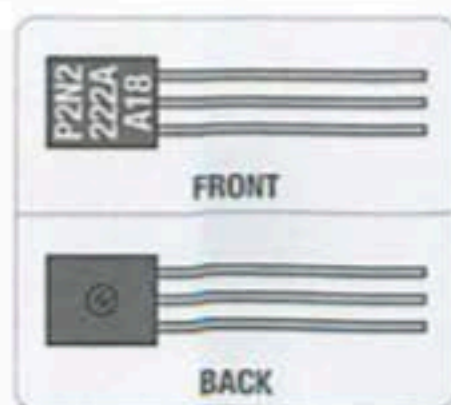
FRONT

BACK

Transistor
(P2N2222AG)



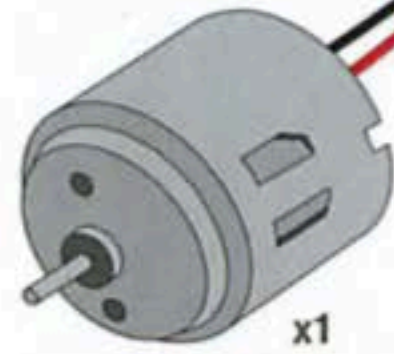
x2



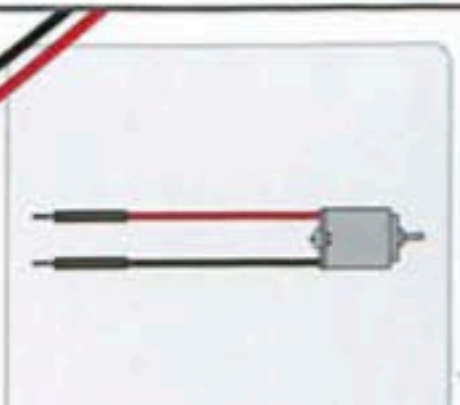
FRONT

BACK

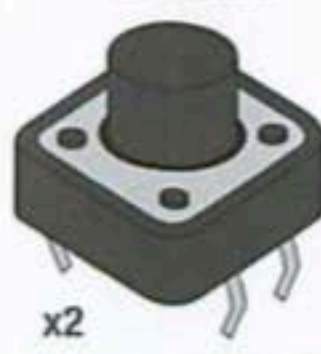
DC Motor



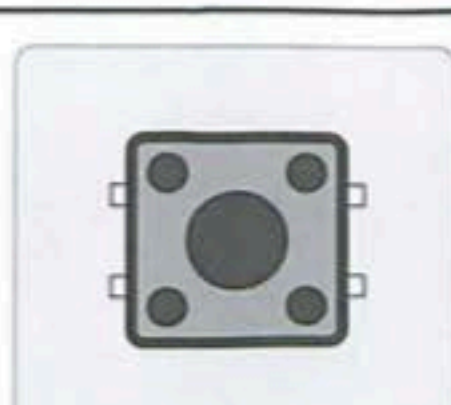
x1



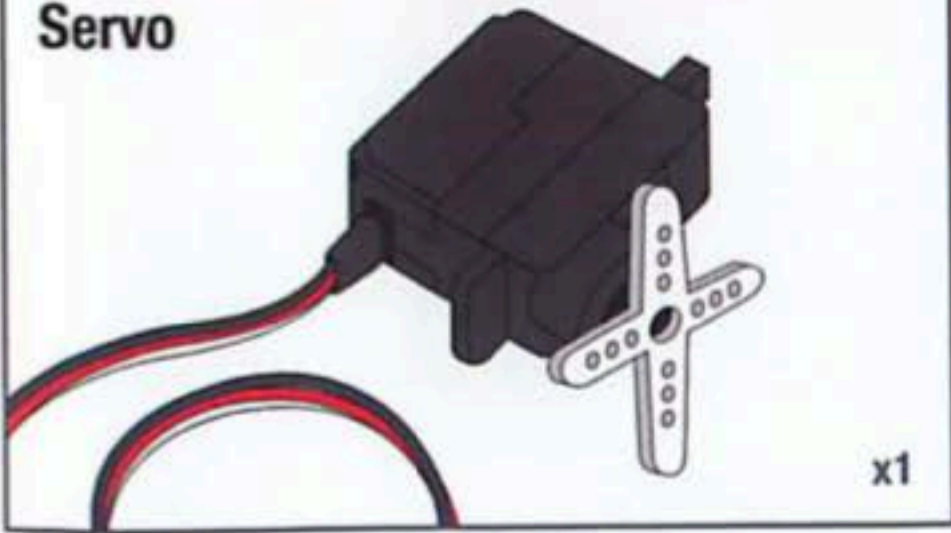
Push Button



x2



Servo



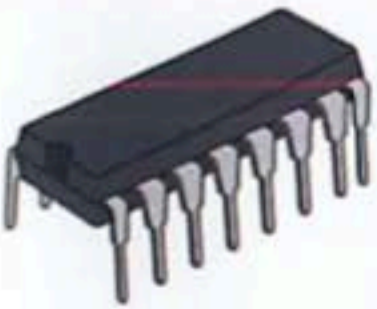
Arduino Board UNO - SMD Version



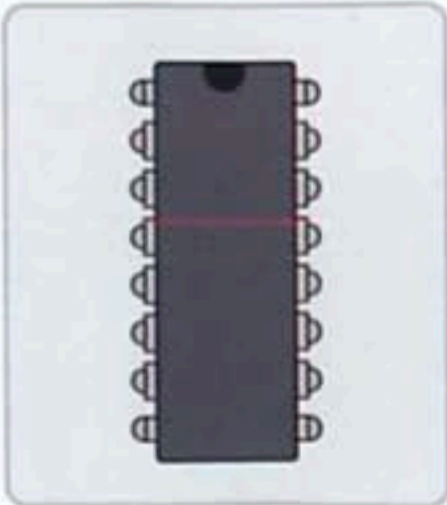
Relay



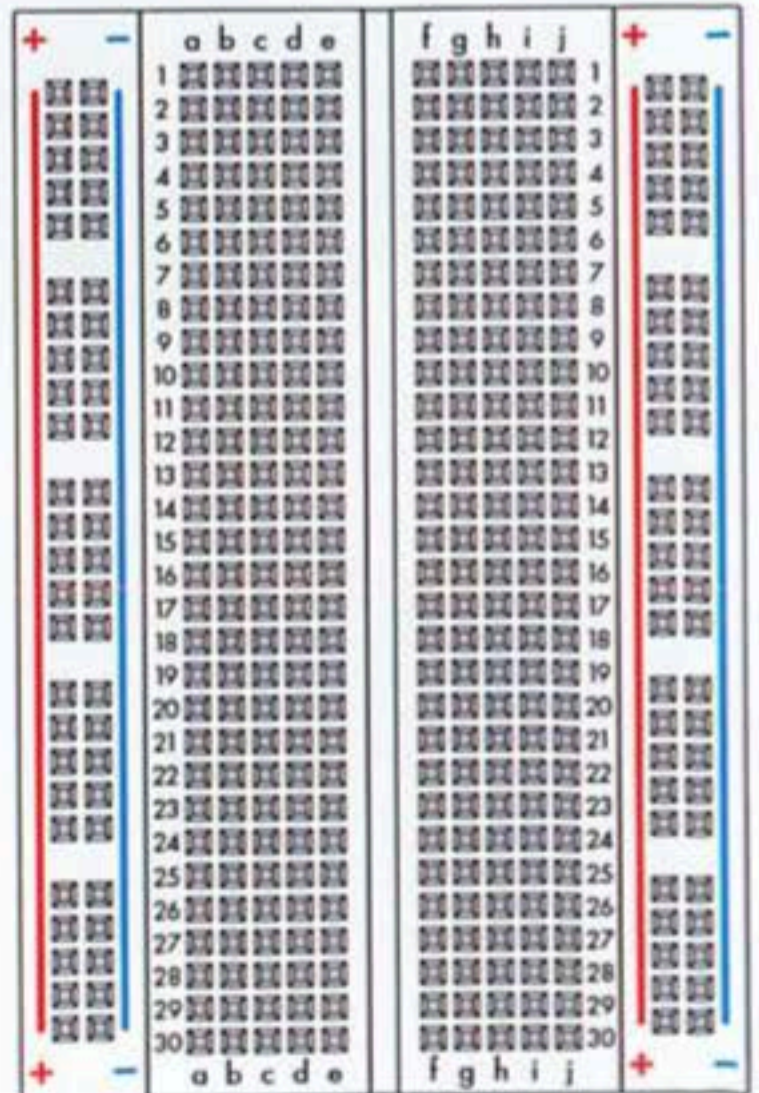
Integrated Circuit (IC)

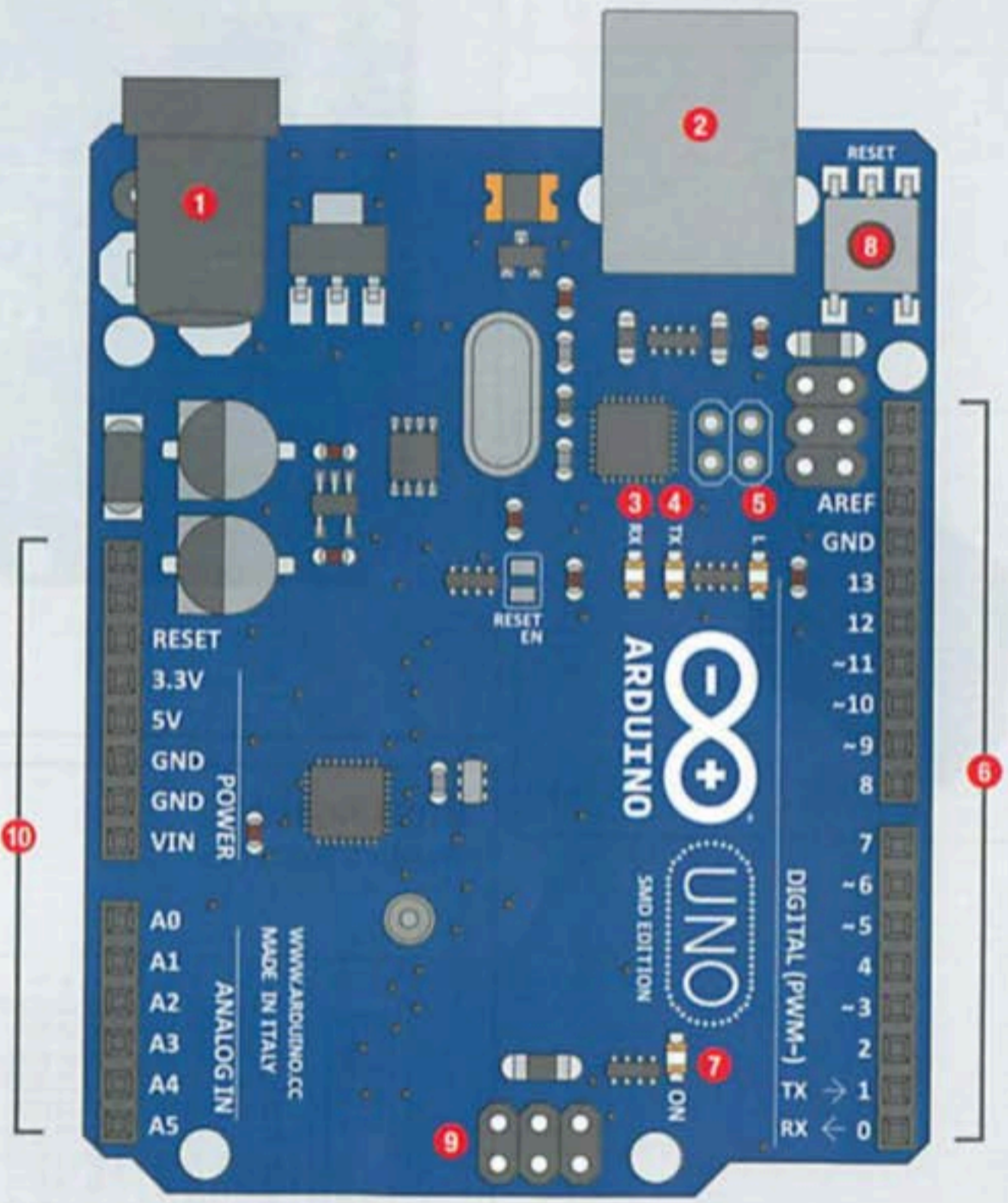


x1



Breadboard Standard Solderless





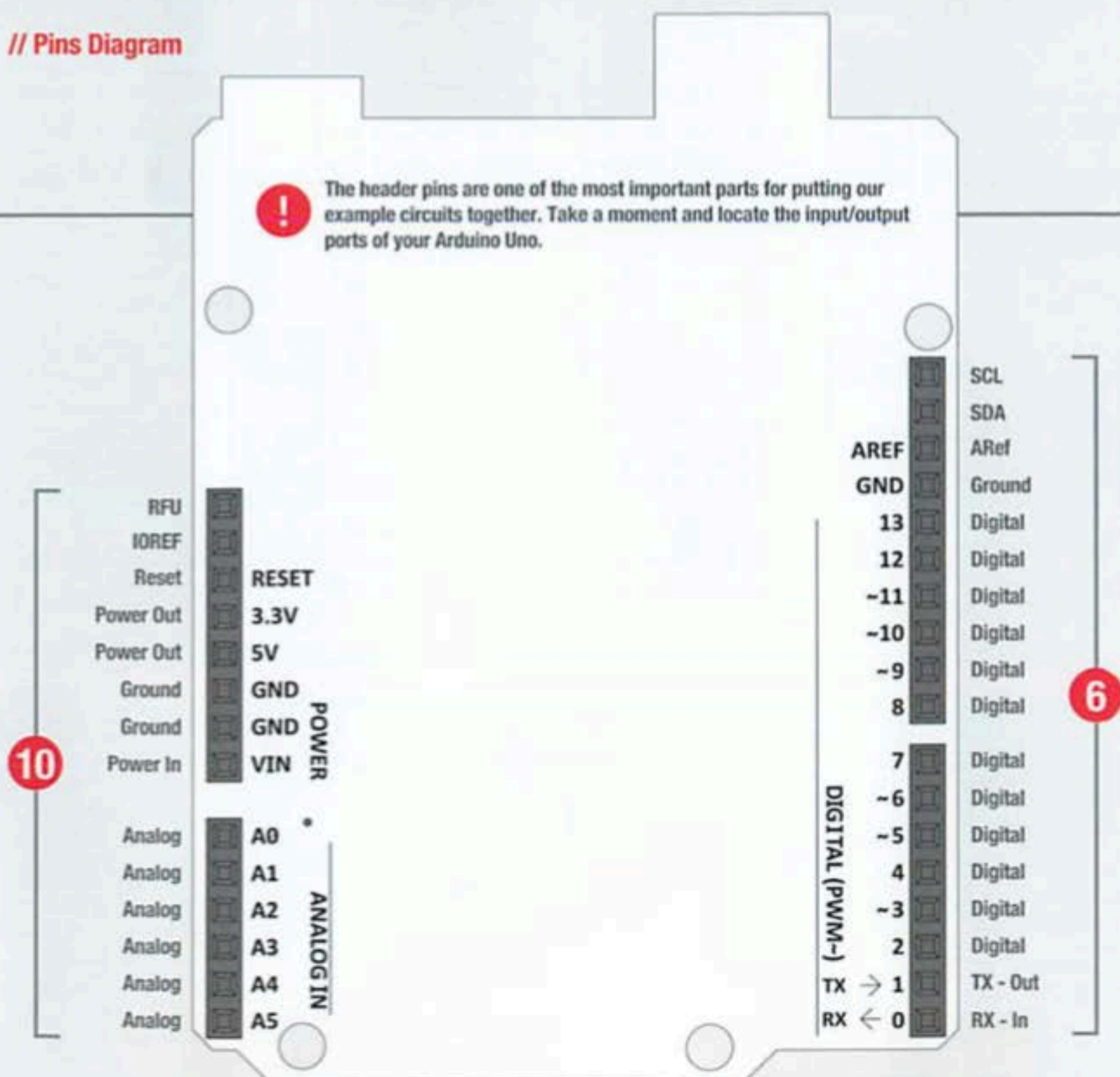
Arduino Uno

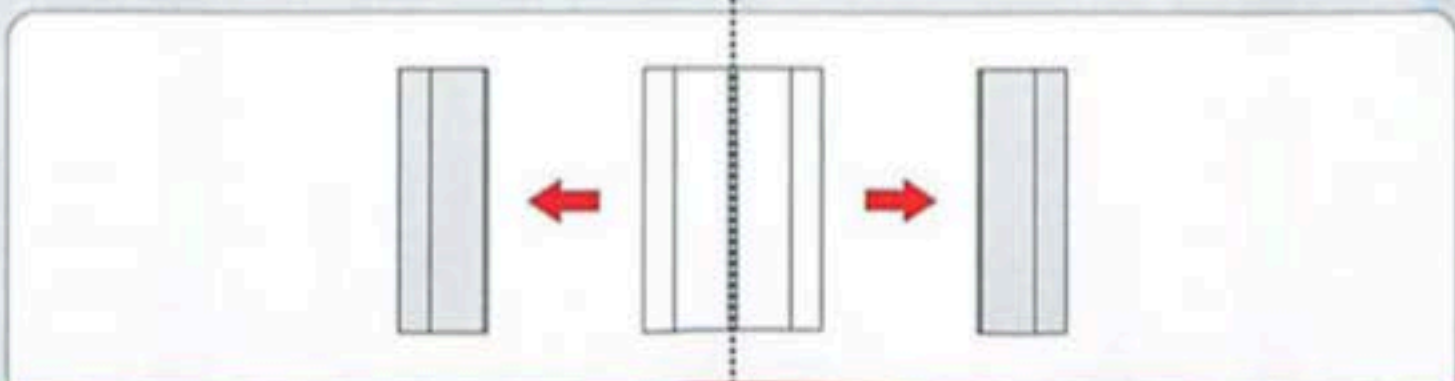
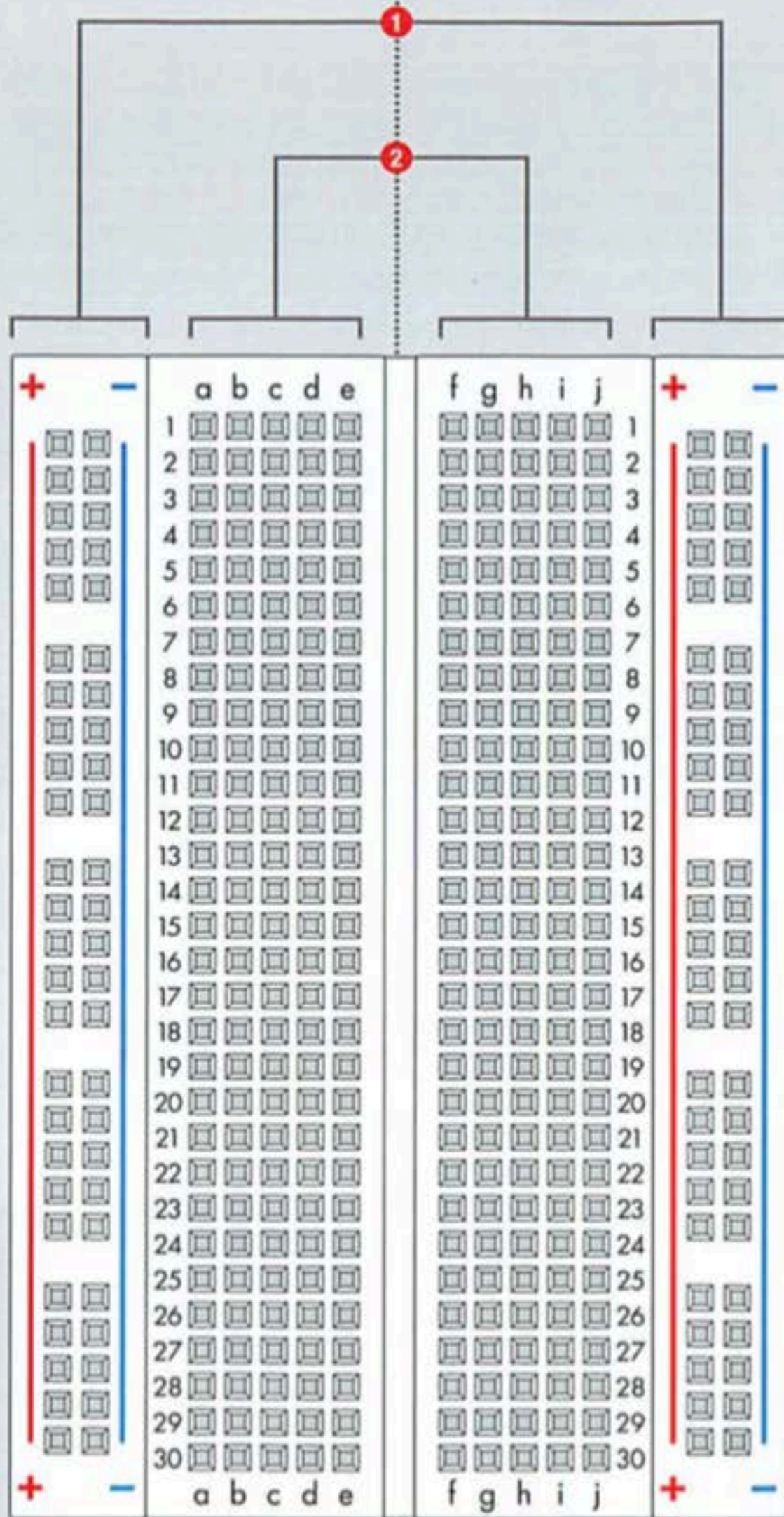
- 1** Power In (Barrel Jack) - Can be used with either a 9V or 12V wall-wart or battery.
- 2** Power In (USB Port) - Provides power and communicates with your board when plugged into your computer via USB.
- 3** LED (RX: Receiving) - This shows when the Arduino is receiving data (such as when being programmed).
- 4** LED (TX: Transmitting) - This shows when your Arduino is transmitting data (such as when running a program).
- 5** LED (Pin 13: Troubleshooting) - This LED is incorporated into your sketch to show if your program is running properly.
- 6** Pins (AREf, Ground, Digital, Rx, Tx) - These various pins can be used for inputs, outputs, power, and ground. // See Diagram Below
- 7** LED (Indicates Arduino is ON) - This is a simple power indicator LED.
- 8** Reset Button - This is a way to manually reset your Arduino, which makes your code restart.
- 9** ICSP Pins (Uploading Code without Bootloader) - This is for "In-Circuit Serial Programming," used if you want to bypass the boot loader.
- 10** Pins (Analog In, Power In, Ground, Power Out, Reset) - These various pins can be used for inputs, outputs, power, and ground. // See Diagram Below

// Pins Diagram



The header pins are one of the most important parts for putting our example circuits together. Take a moment and locate the input/output ports of your Arduino Uno.





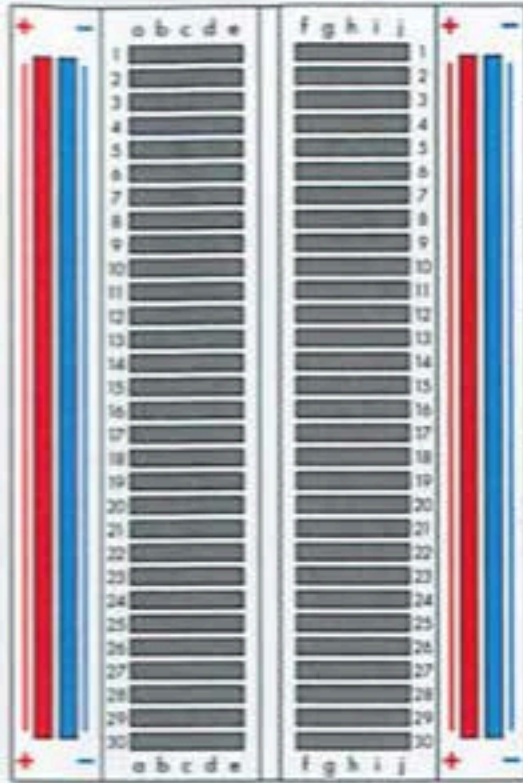
This line divides the board in half, restricting electricity to one half or the other.

Breadboard

1 Vertical Connection (+ Power and - Ground // See Diagram Below)

2 Horizontal Connection (a-e & f-j // See Diagram Below)

How's it all connected?



+ Power:

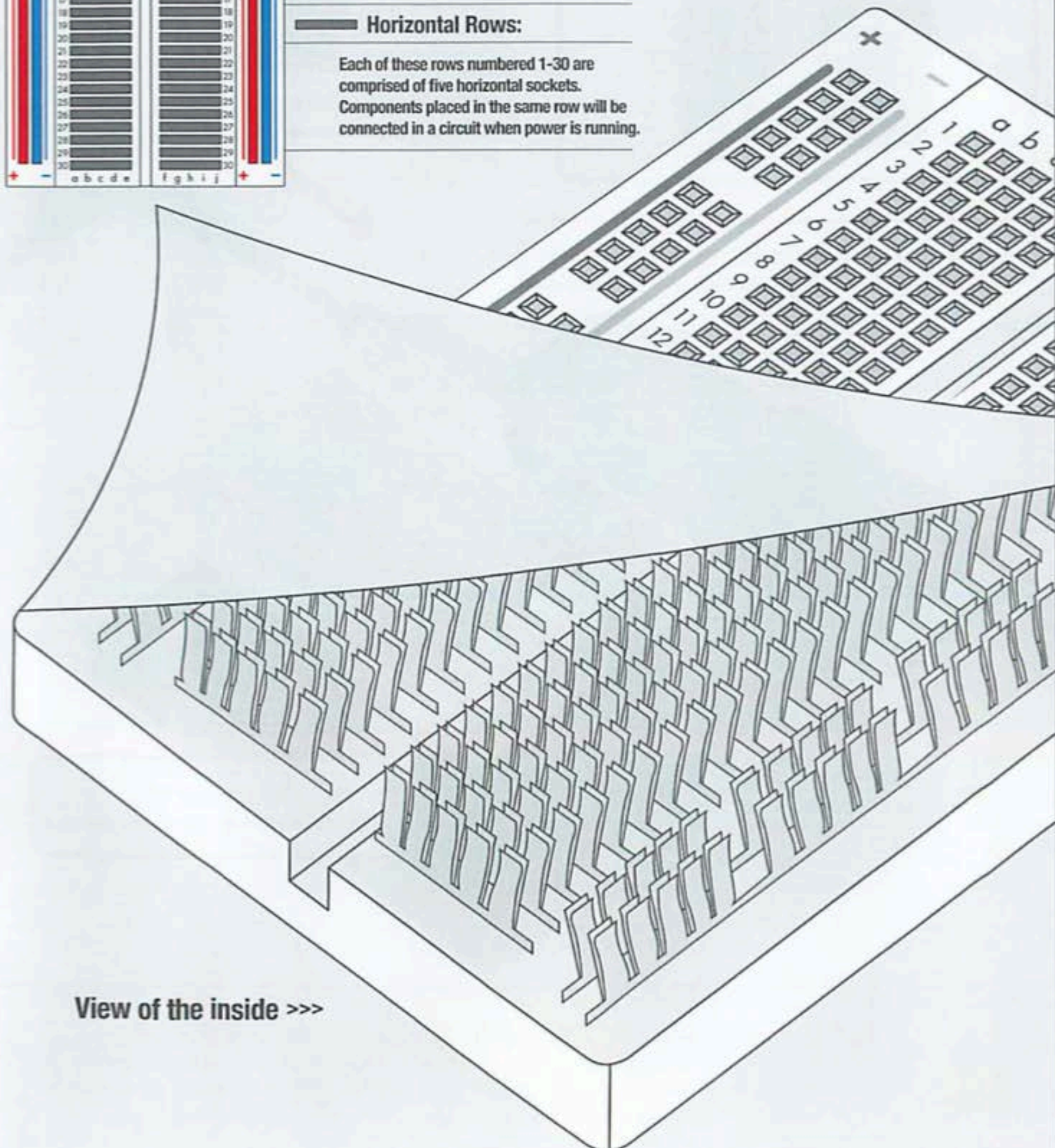
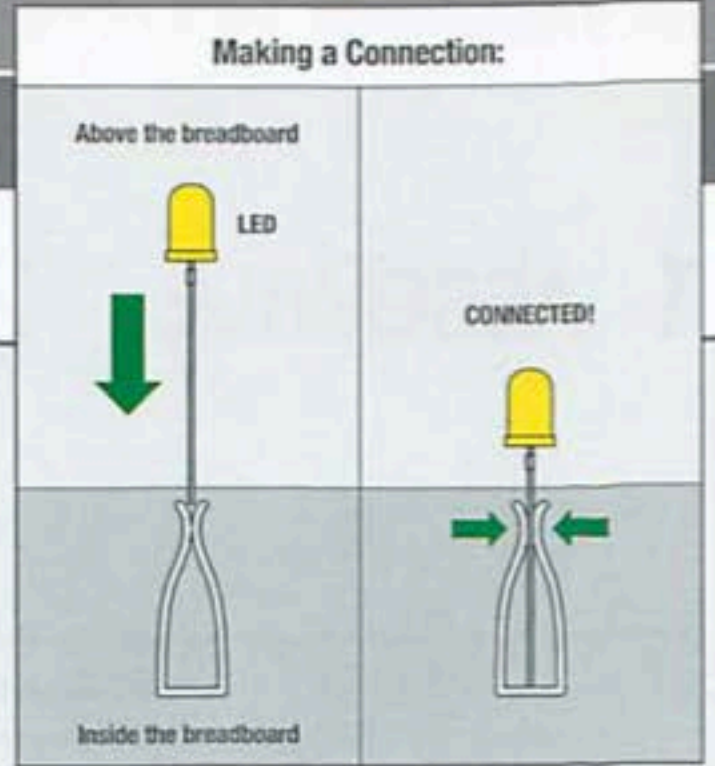
Each + sign runs power anywhere in the vertical column.

- Ground:

Each - sign runs to ground anywhere in the vertical column.

Horizontal Rows:

Each of these rows numbered 1-30 are comprised of five horizontal sockets. Components placed in the same row will be connected in a circuit when power is running.



View of the inside >>>

CIRCUIT #1 - Your First Circuit

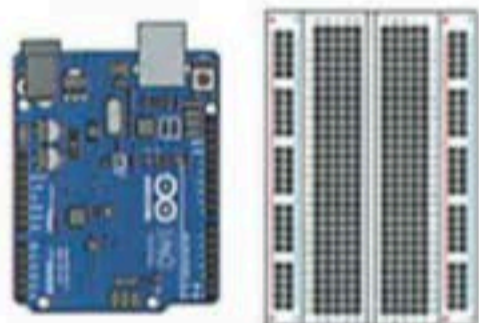
How It Works:

1 ASSEMBLE

2 WRITE

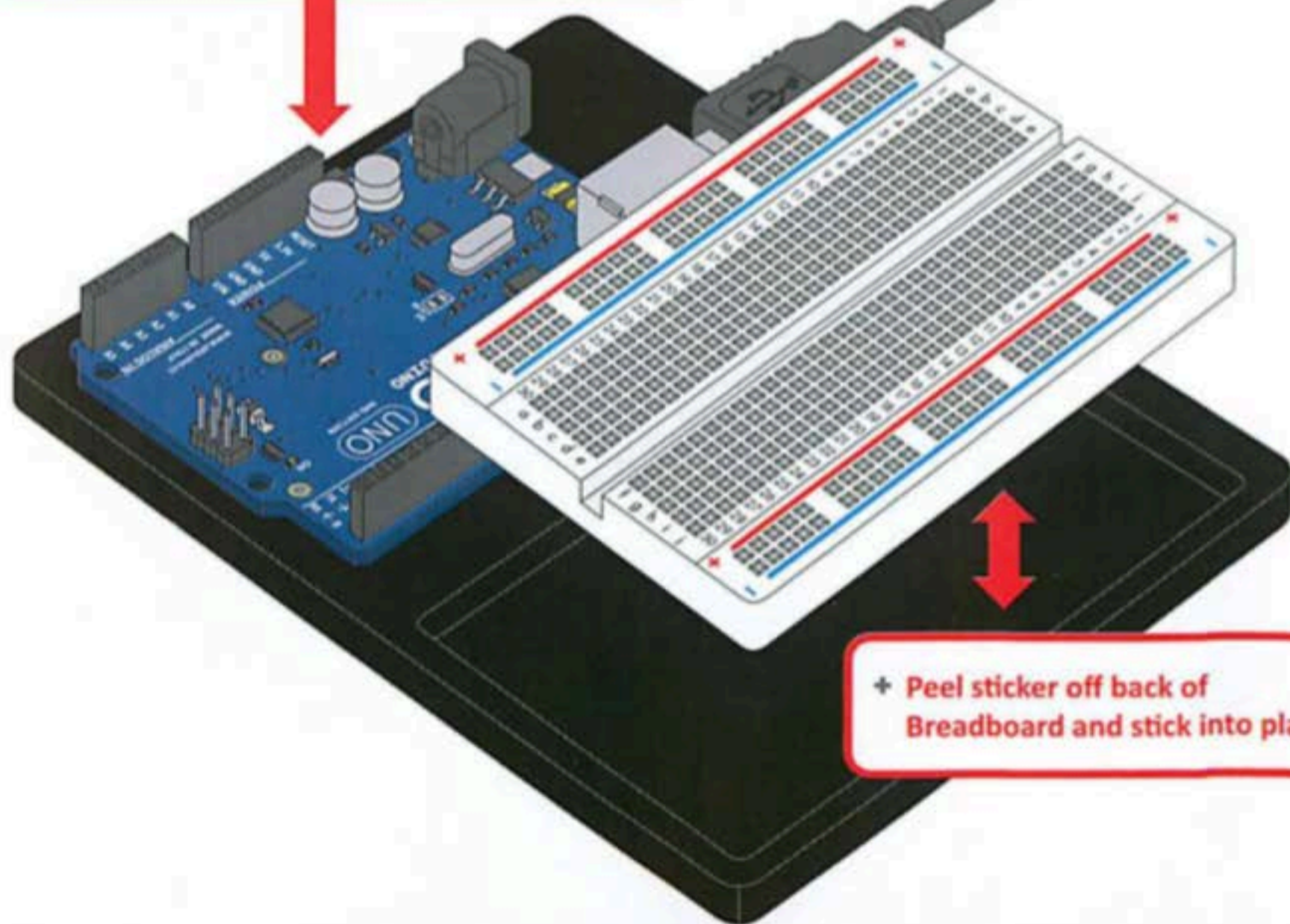
3 UPLOAD

+ Make sure the text on the Arduino and Breadboard are facing up so you can read them.



+ Connect the USB cable.

+ Screw the Arduino board down and into place.



+ Peel sticker off back of Breadboard and stick into place.

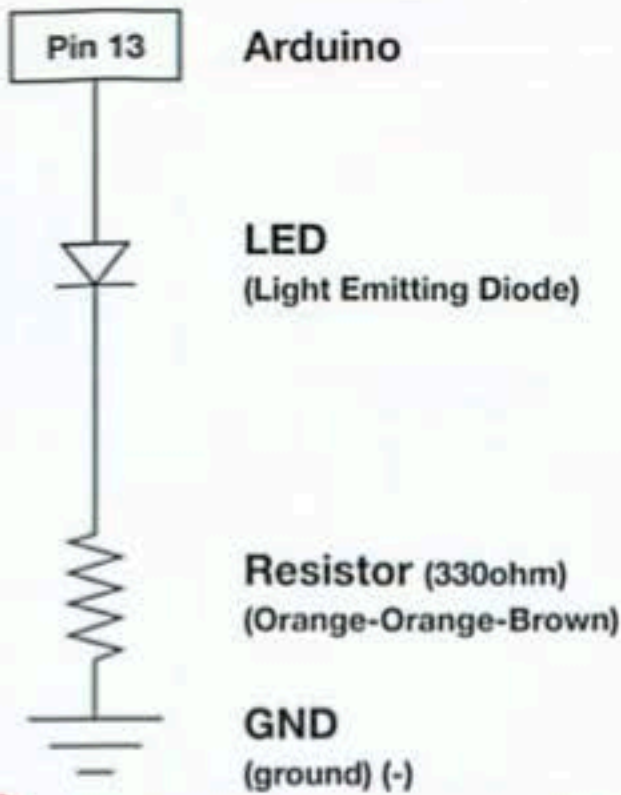


5V Current Your Arduino runs on five volts. This is the power that will be supplied from your computer via USB and will be the driving force behind any components you use in your circuits. By plugging your Arduino board into your computer, you are supplying it with just the right voltage it needs to thrive! 5V can't hurt you, so don't be afraid to touch anything in your circuit.

Blinking a LED

LEDs (light-emitting diodes) are small, powerful lights that are used in many different applications. To start off the USK, we will work on blinking an LED. That's right - it's as simple as turning a light on and off. It might not seem like much, but establishing this important baseline will give you a solid foundation as we work toward more complex experiments.

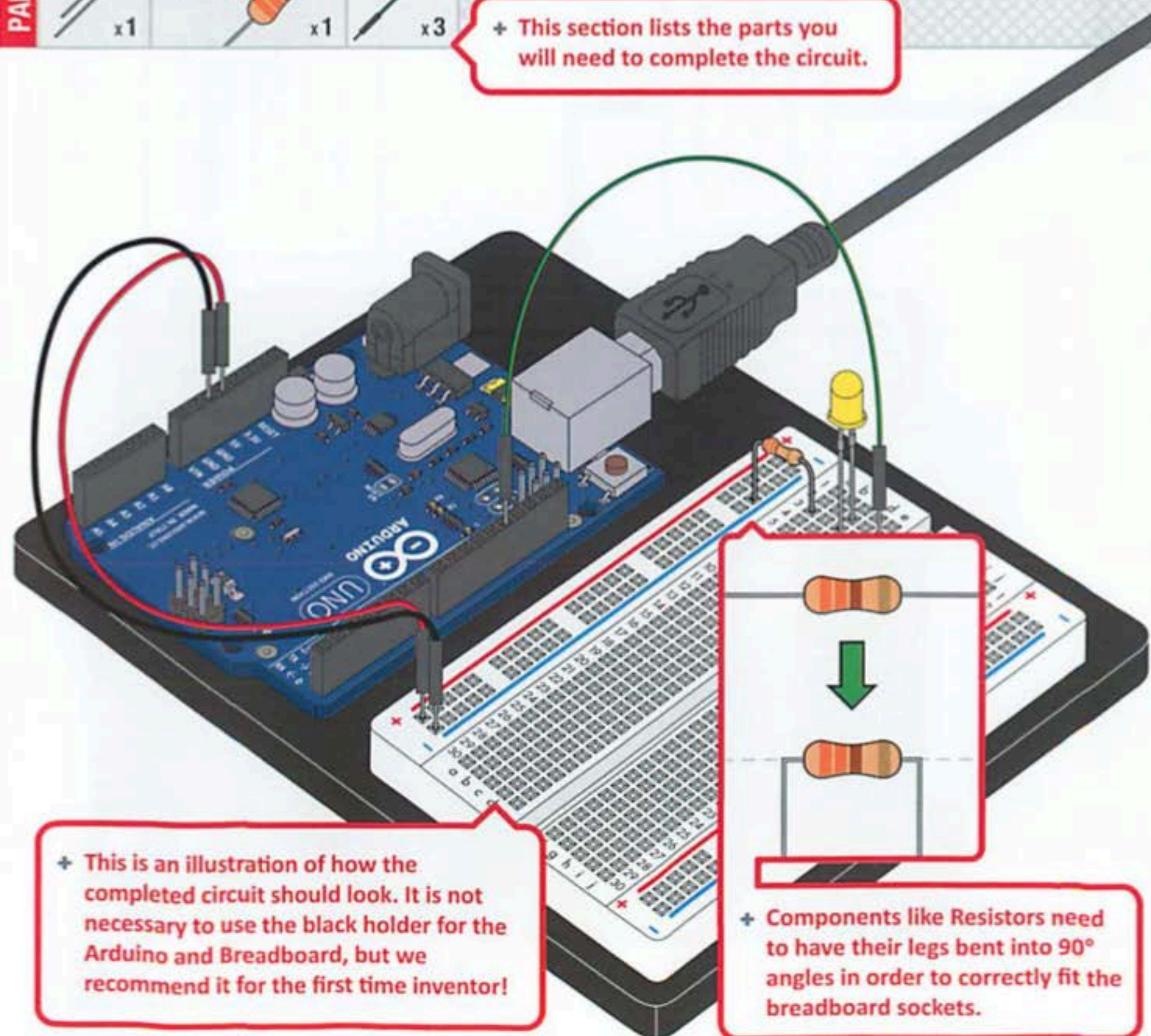
+ Each Circuit begins with a brief description of the what you are putting together and the expected result.



+ This is a schematic of your circuit.

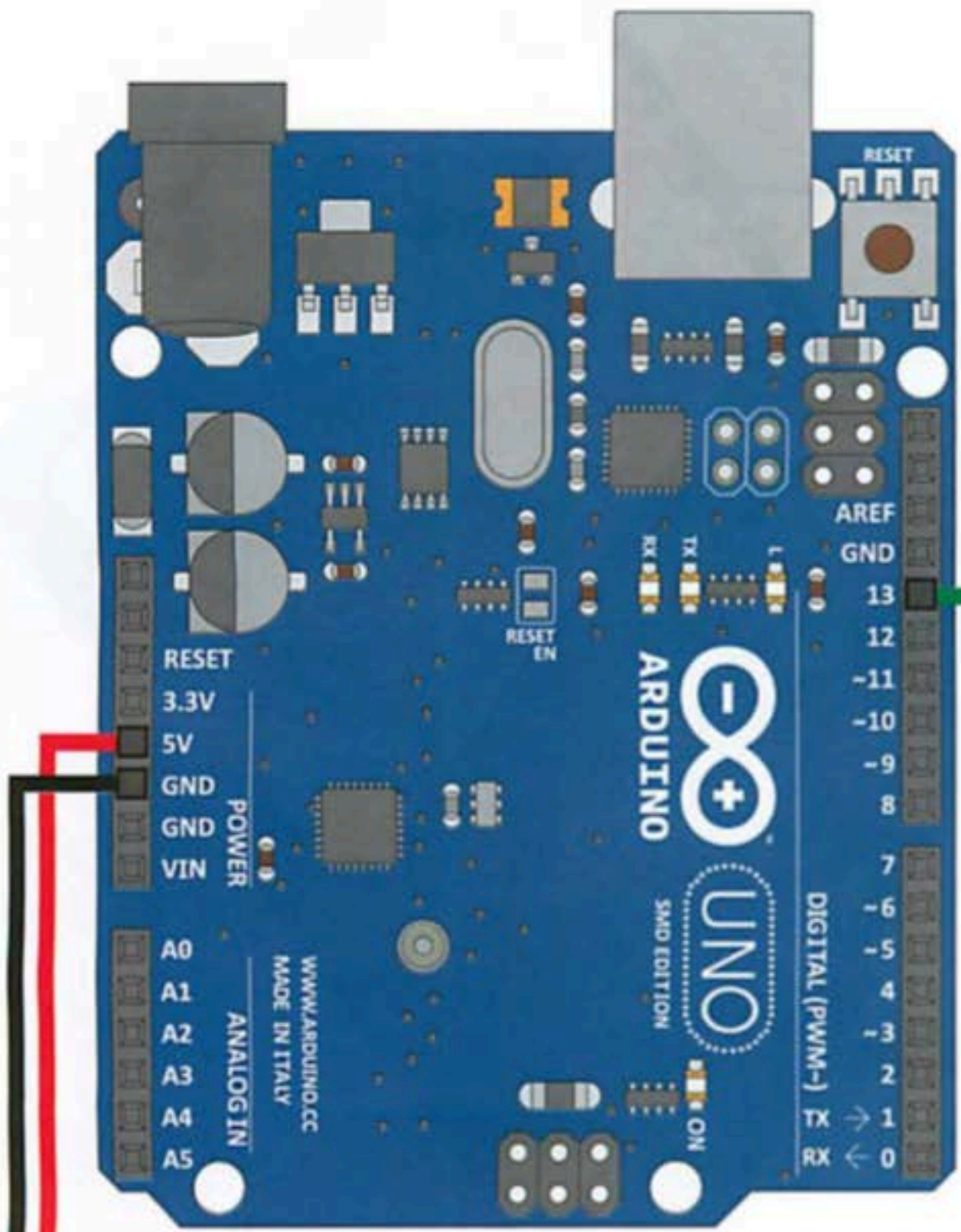


+ This section lists the parts you will need to complete the circuit.



+ This is an illustration of how the completed circuit should look. It is not necessary to use the black holder for the Arduino and Breadboard, but we recommend it for the first time inventor!

+ Components like Resistors need to have their legs bent into 90° angles in order to correctly fit the breadboard sockets.



+ 330Ω Resistor: The color banding should read orange-orange-brown-gold. The component legs can go in either hole.

+ Jumper Wire: All jumper wires work the same. They are used to connect two points together. This guide will show the wires with different colored insulations for clarity, but using different combinations of colors is completely acceptable.

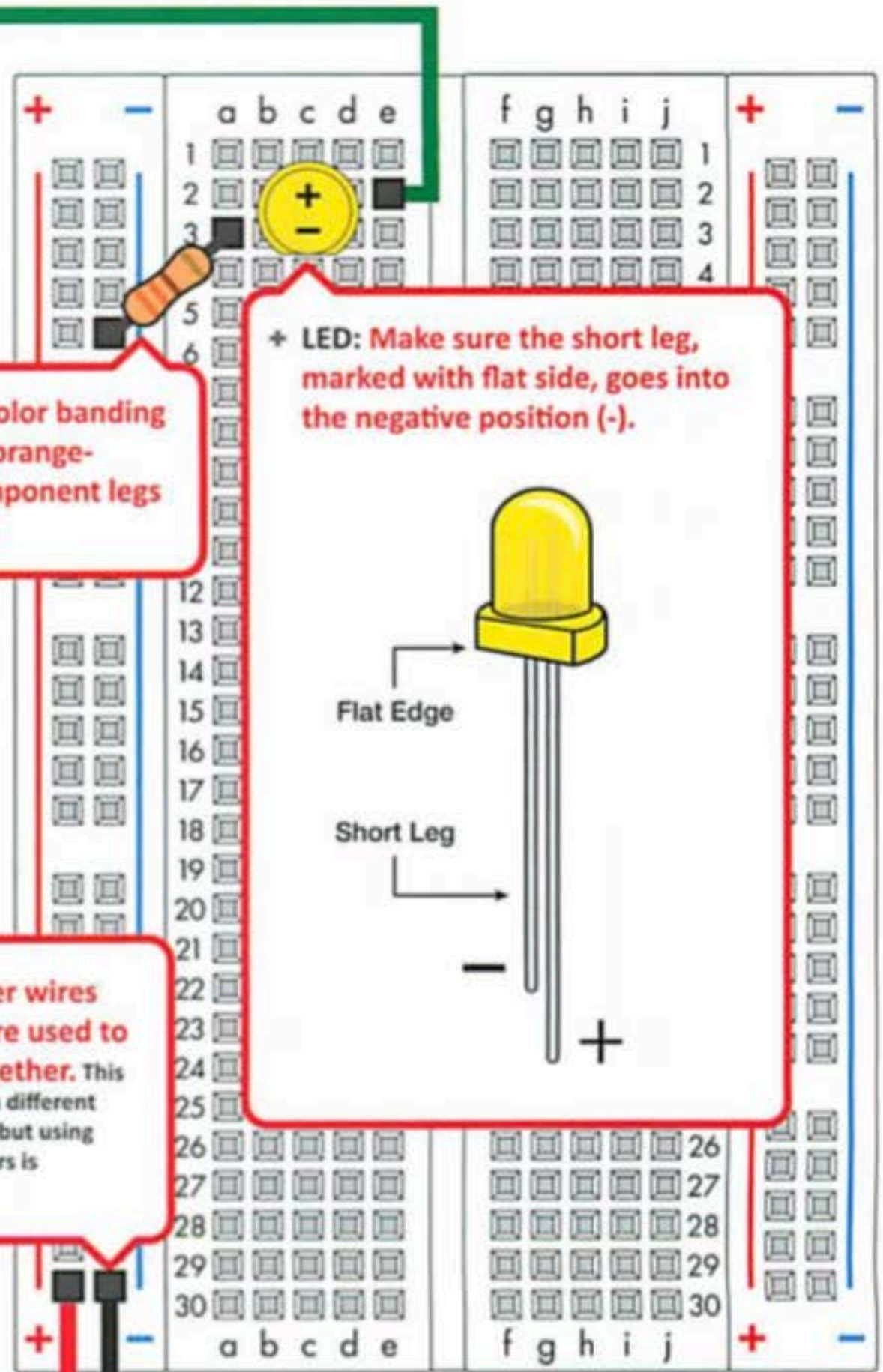
+ LED: Make sure the short leg, marked with flat side, goes into the negative position (-).


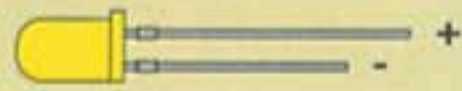

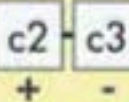

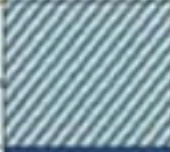








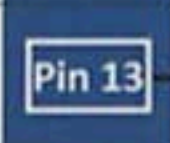

Flat Edge

Short Leg

-

+

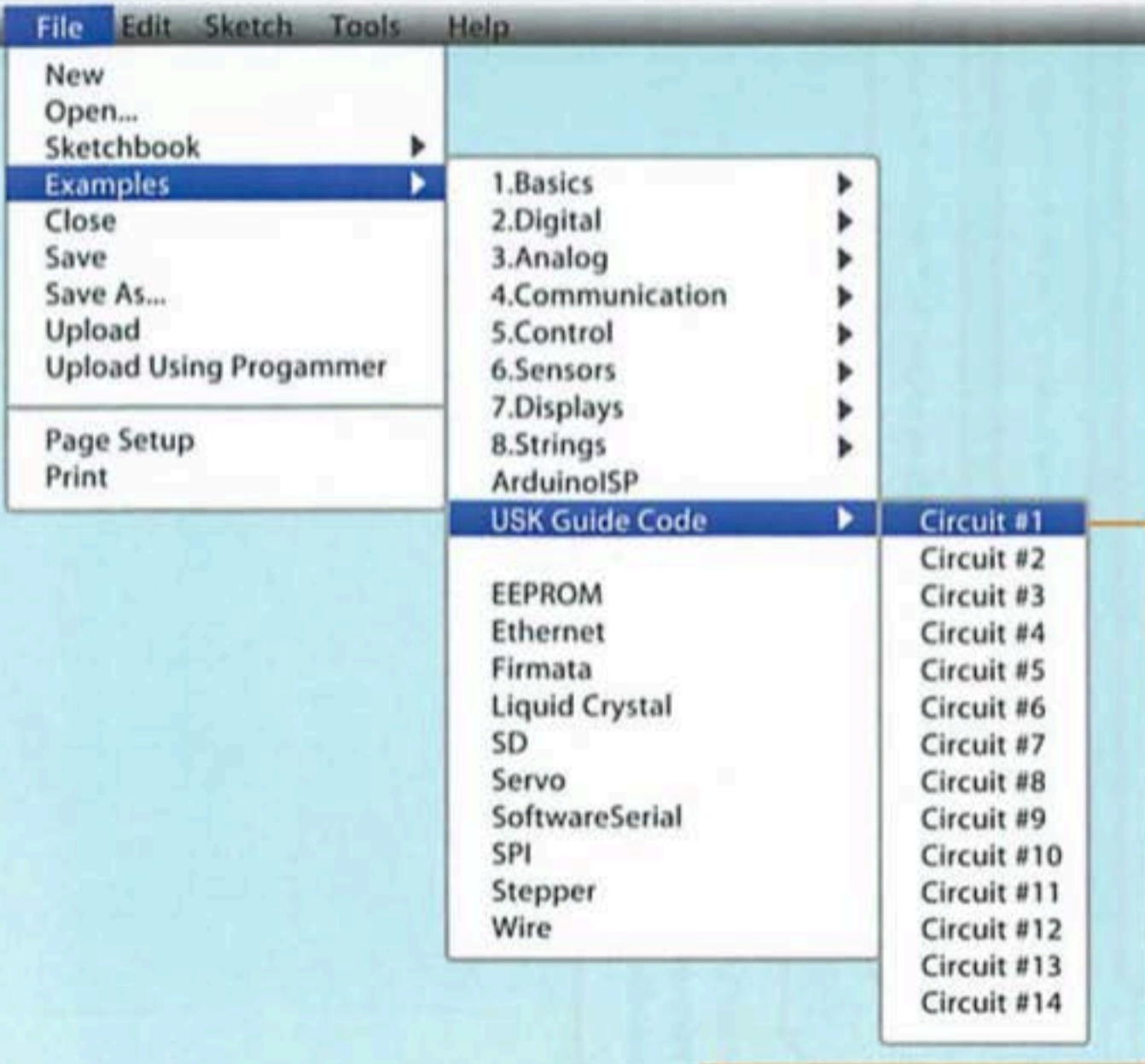


Component:	Image Reference:			
LED (5mm) 				+ Components like LEDs are inserted into the Breadboard sockets c2(long leg) c3(short leg).
330Ω Resistor				+ Resistors are placed in Breadboard sockets only. The "-" symbol represents any socket in its vertical column.
Jumper Wire				+ "GND" on the Arduino should be connected to the row marked "-" on the Breadboard.
Jumper Wire				+ "5V" on the Arduino connects to the row marked "+" on the Breadboard.
Jumper Wire				+ "Pin 13" on the Arduino connects to socket "e2" on the Breadboard.
				<div data-bbox="680 904 1407 1162">+ Arduino: The blue background represents a connection to one of the Arduino header pins.</div> <div data-bbox="1439 904 2167 1162">+ Breadboard: The white background represents a connection to a breadboard socket.</div>



Open Your First Sketch:

Open Up the Arduino IDE software on your computer. Coding in the Arduino language will control your circuit. Open the code for Circuit 1 by accessing the "USK Guide Code" you downloaded and placed into your "Example" folder earlier.



// Circuit #1

```

Circuit #1

/*
 * Blink
 * Turns on an LED on for one second,
 * then off for one second, repeatedly.
 * This example code is in the public domain.
 */

void setup() {
  // initialize the digital pin as an output.
  // Pin 13 has an LED connected on most Arduino boards:
  pinMode(13, OUTPUT);
}

void loop() {
  digitalWrite(13, HIGH); // set the LED on
  delay(1000);           // wait for a second
  digitalWrite(13, LOW); // set the LED off
  delay(1000);          // wait for a second
}

```



Verify

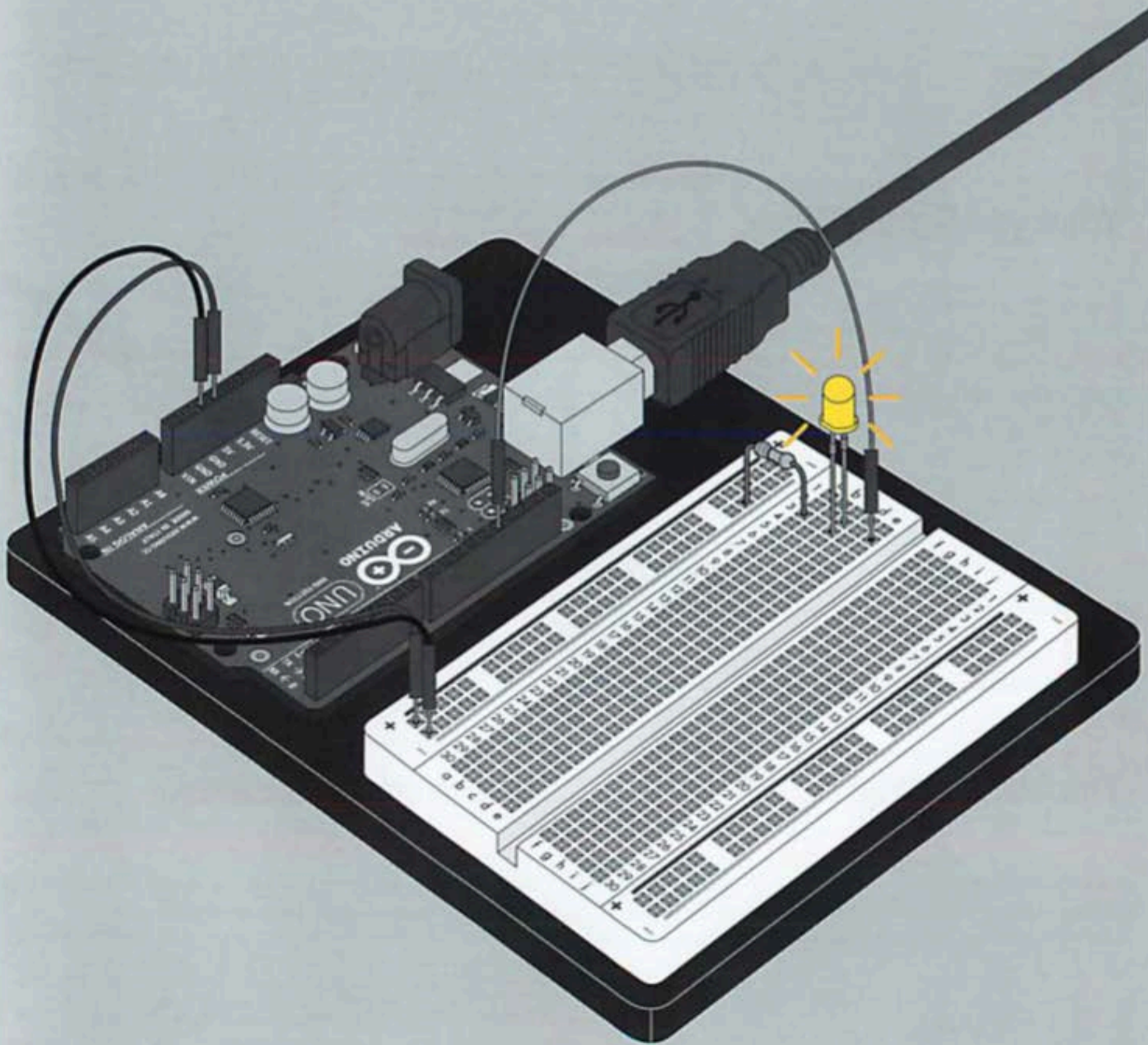
This compiles your code. The IDE changes it from text into instructions the computer can understand.



Upload

This sends the instructions via the USB cable to the computer chip on the Arduino board. The Arduino will then begin running your code automatically.

// The result of a completed circuit with correct code after verified and uploaded.



1

+ This is where you will find the Arduino code for each circuit.



Open Arduino IDE // File > Examples > USK Guide > Circuit # 1

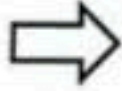
Code to Note:

+ Remember to Verify and Upload your code.



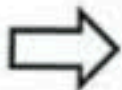
+ Begin to understand how the Arduino code works. See below.

`pinMode(13, OUTPUT);`



Before you can use one of the Arduino's pins, you need to tell the Arduino whether it is an INPUT or OUTPUT. We use a built-in "function" called `pinMode()` to do this.

`digitalWrite(13, HIGH);`

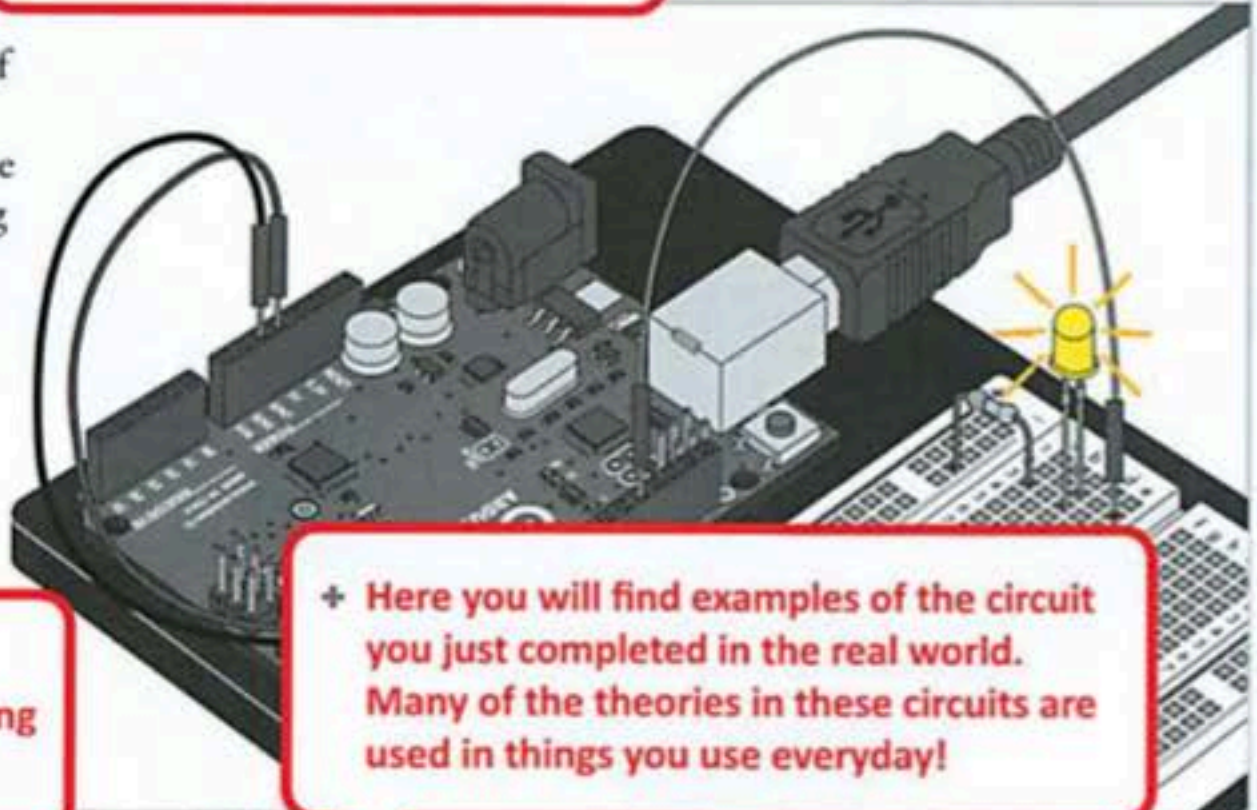


When you're using a pin as an OUTPUT, you can command it to be HIGH (output 5 Volts), or LOW (output 0 Volts).

What you Should See:

+ See if your circuit is complete and working in this section.

You should see your LED blink on and off. If it isn't, make sure you have assembled the circuit correctly and verified and uploaded the code to your board or see the troubleshooting tips below.



+ This is a section dedicated to the most common mistakes made while assembling the circuit.

+ Here you will find examples of the circuit you just completed in the real world. Many of the theories in these circuits are used in things you use everyday!

Troubleshooting:

Real World Application:

LED Not Lighting Up?

LEDs will only work in one direction. Try taking it out and twisting it 180 degrees (no need to worry, installing it backwards does no permanent harm).

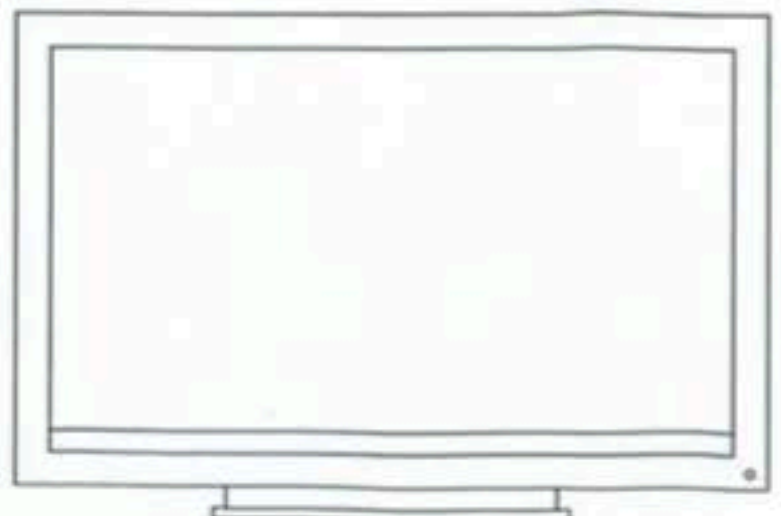
Program Not Uploading

This happens sometimes, the most likely cause is a confused serial port, you can change this in `tools>serial port>`

Still No Success?

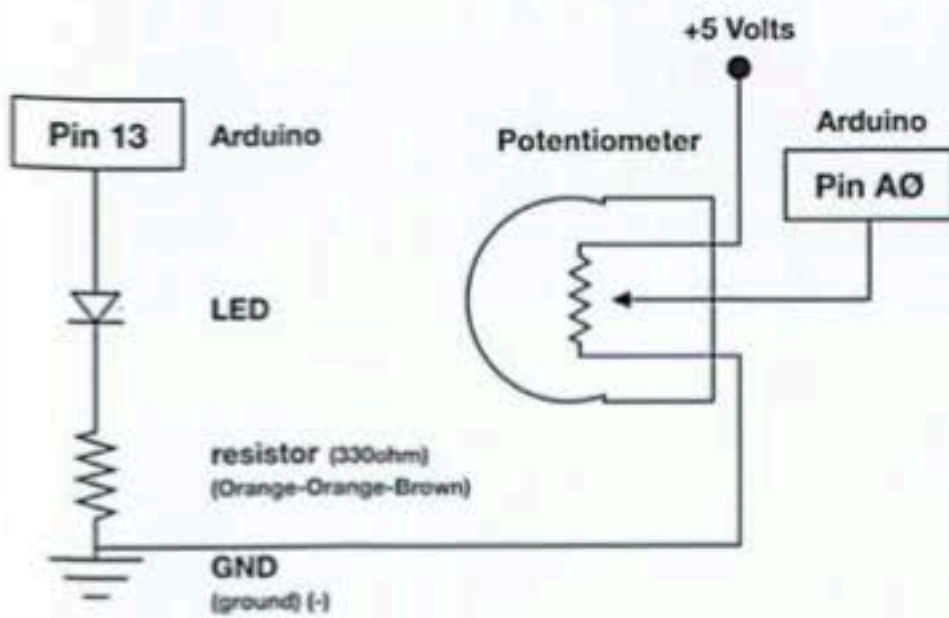
A broken circuit is no fun, send us an e-mail and we will get back to you as soon as we can: techsupport@vilros.com

Almost all modern flat screen televisions and monitors have LED indicator lights to show they are on or off.



Potentiometer

In this circuit you'll work with a potentiometer. A potentiometer is also known as a variable resistor. When it's connected with 5 volts across its two outer pins, the middle pin outputs a voltage between 0 and 5, depending on the position of the knob on the potentiometer. In this circuit, you'll learn how to use a potentiometer to control the brightness of an LED.



PARTS:

Potentiometer

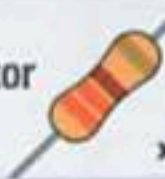


x1

LED



x1

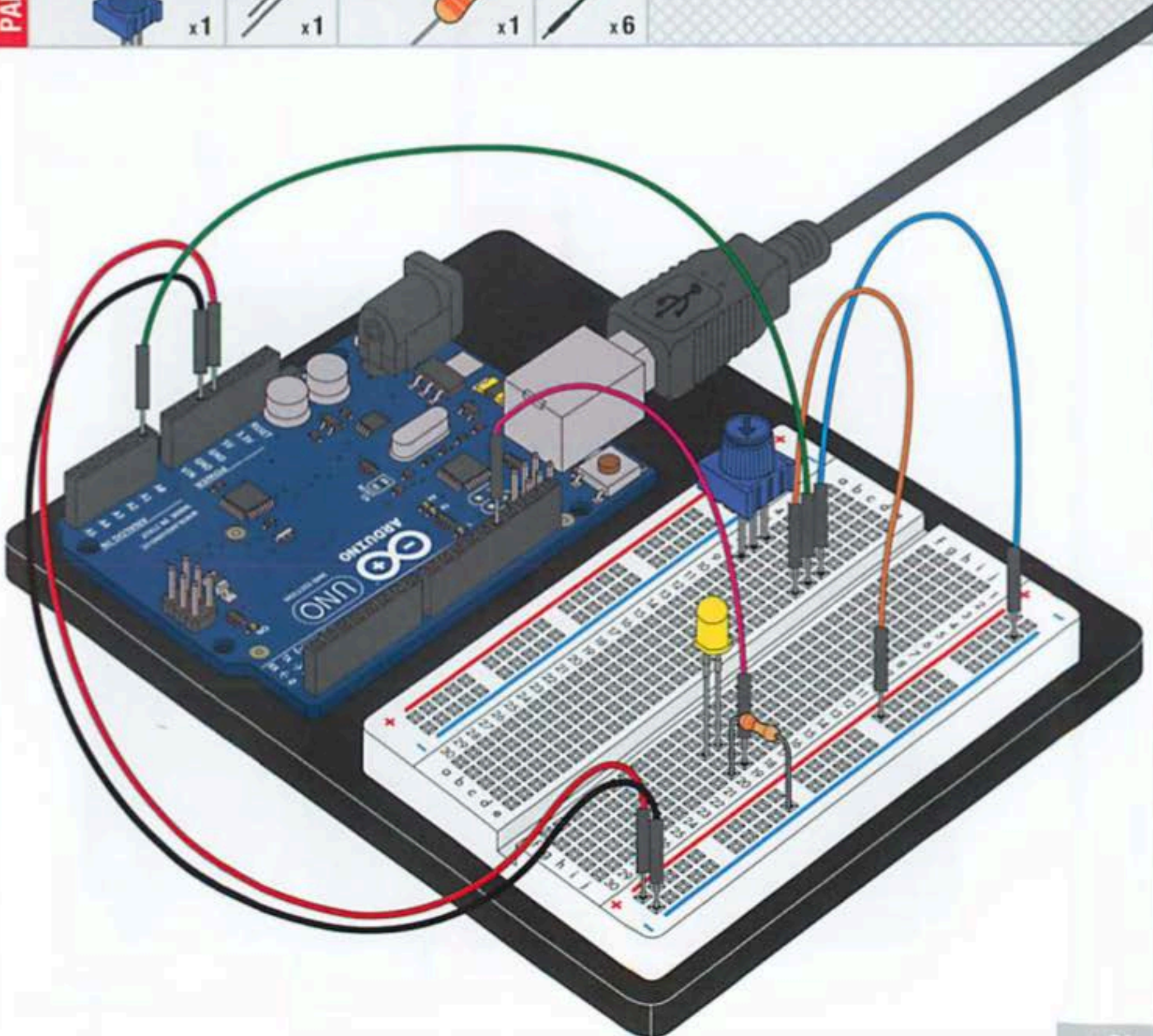
330Ω
Resistor

x1

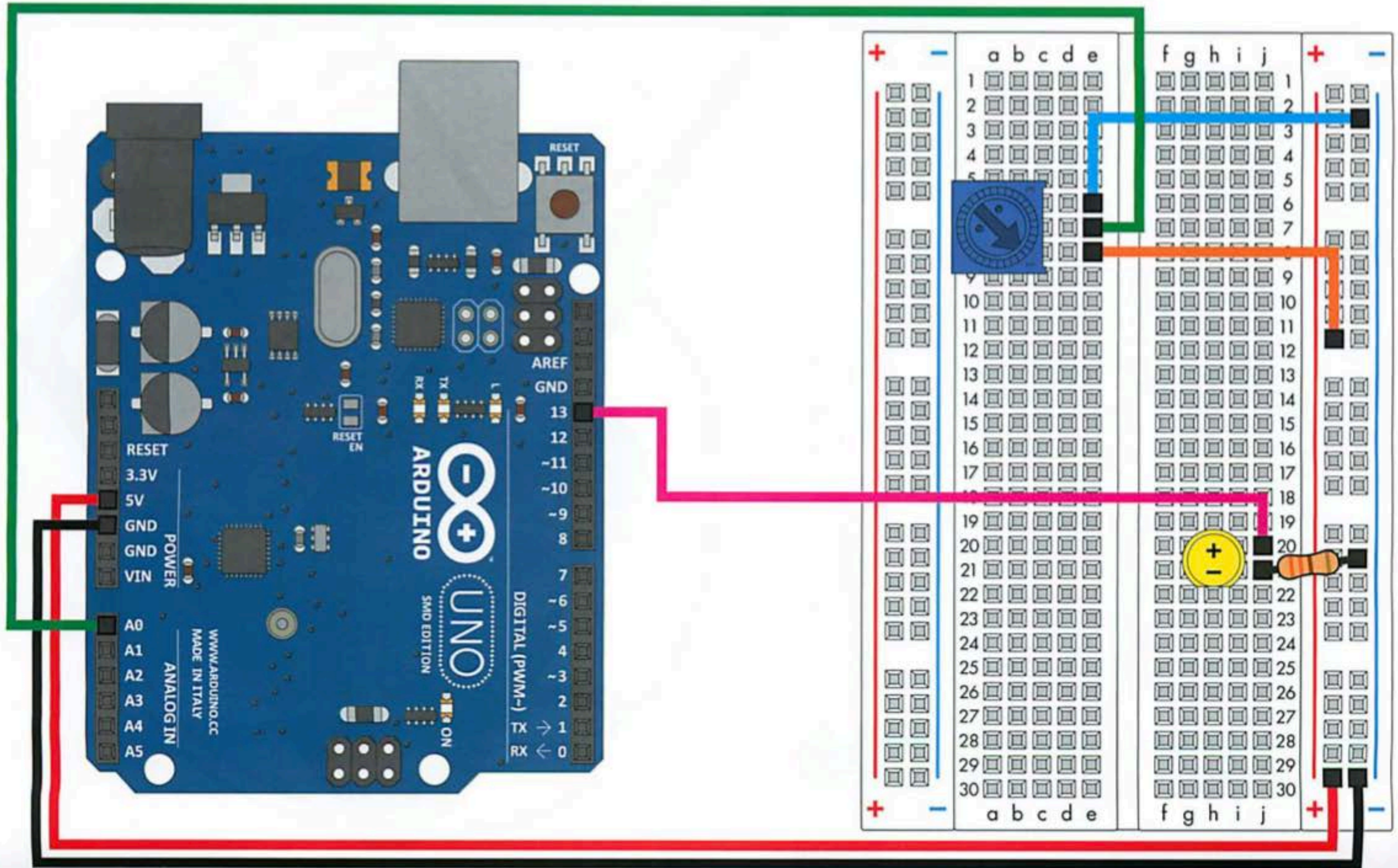
Wire


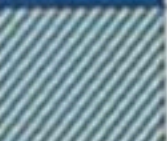
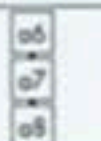
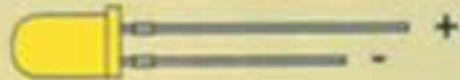

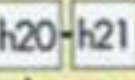







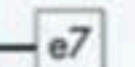

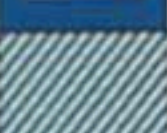


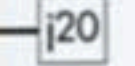






x6



Circuit 2: Potentiometer



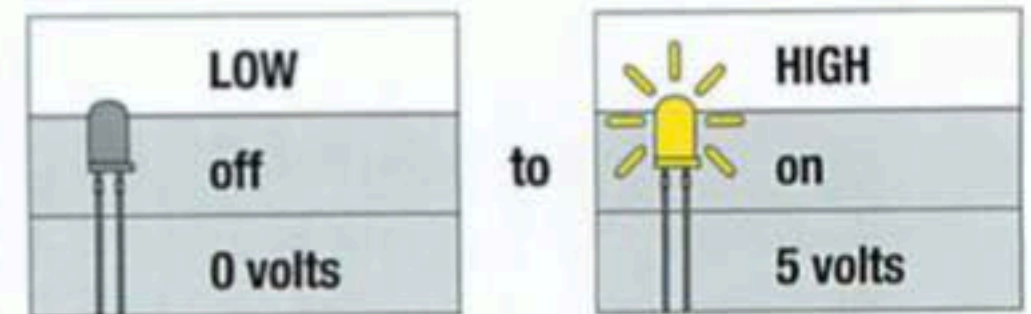
Component:	Image Reference:		
Potentiometer			
LED (5mm)			
330Ω Resistor			
Jumper Wire			
Jumper Wire		A8	
Jumper Wire			
Jumper Wire		Pin 13	
Jumper Wire		5V	
Jumper Wire		GND	

Digital versus Analog:

If you look closely at your Arduino, you'll see some pins labeled "DIGITAL", and some labeled "ANALOG". What's the difference?

Many of the devices you'll interface to, such as LEDs and pushbuttons, have only two possible states: on and off, or as they're known to the Arduino, "HIGH" (5 Volts) and "LOW" (0 Volts). The digital pins on an Arduino are great at getting these signals to and from the outside world, and can even do tricks like simulated dimming (by blinking on and off really fast), and serial communications (transferring data to another device by encoding it as patterns of HIGH and LOW).

DIGITAL



But there are also a lot of things out there that aren't just "on" or "off". Temperature levels, control knobs, etc. all have a continuous range of values between HIGH and LOW. For these situations, the Arduino offers six analog inputs that translate an input voltage into a number that ranges from 0 (0 Volts) to 1023 (5 Volts). The analog pins are perfect for measuring all those "real world" values, and allow you to interface the Arduino to all kinds of things.

ANALOG



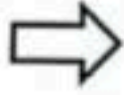


Open Arduino IDE // File > Examples > USK Guide > Circuit # 2

Code to Note:



`int sensorValue;`



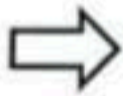
A "variable" is a number you've given a name to. You must introduce, or "declare" variables before you use them; here we're declaring a variable called `sensorValue`, of type "int" (integer). Don't forget that variable names are case-sensitive!

`sensorValue = analogRead(sensorPin);`



We use the `analogRead()` function to read the value on an analog pin. `analogRead()` takes one parameter, the analog pin you want to use ("`sensorPin`"), and returns a number ("`sensorValue`") between 0 (0 Volts) and 1023 (5 Volts).

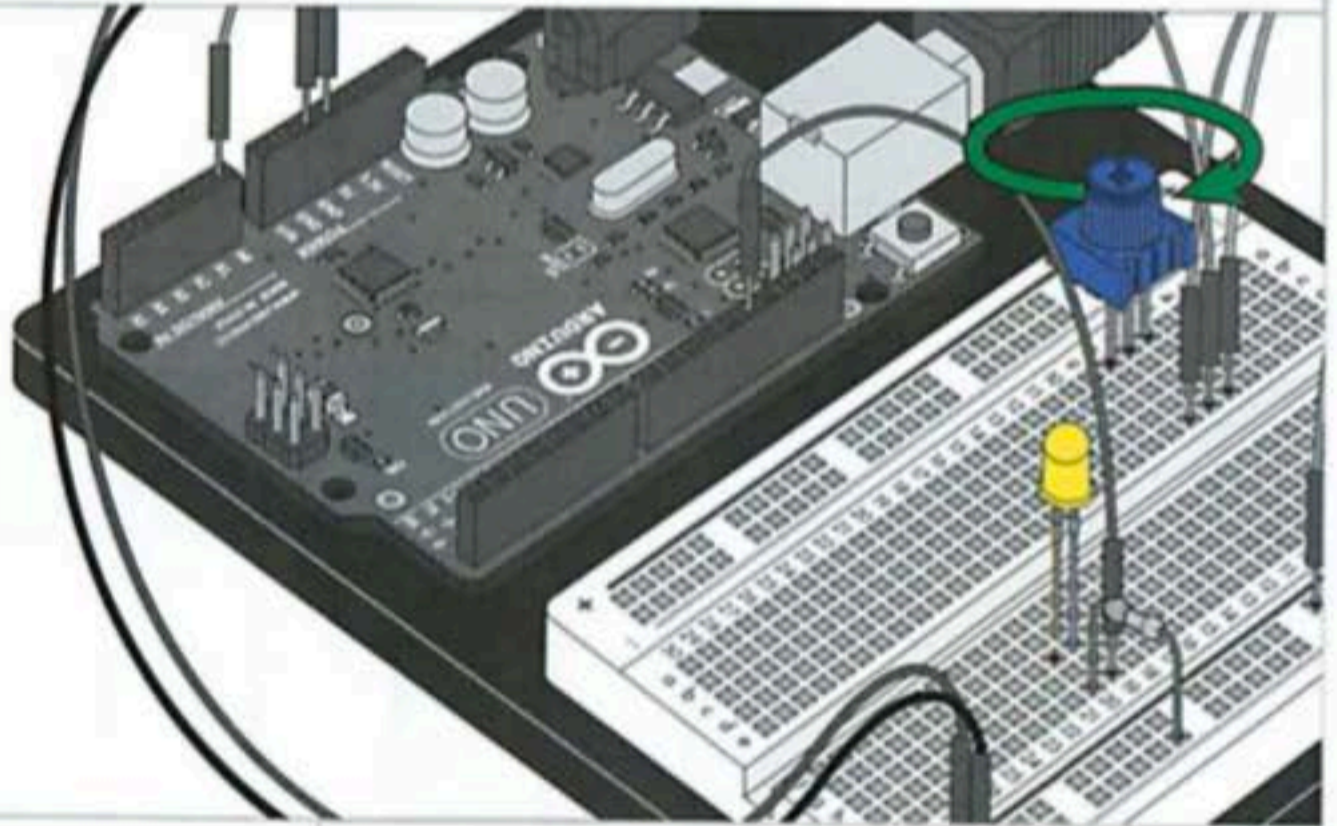
`delay(sensorValue);`



The Arduino is very very fast, capable of running thousands of lines of code each second. To slow it down so that we can see what it's doing, we'll often insert delays into the code. `Delay()` counts in milliseconds; there are 1000 ms in one second.

What you Should See:

You should see the LED blink faster or slower in accordance with your potentiometer. If it isn't working, make sure you have assembled the circuit correctly and verified and uploaded the code to your board or see the troubleshooting tips below.



Troubleshooting:

Sporadically Working

This is most likely due to a slightly dodgy connection with the potentiometer's pins. This can usually be conquered by holding the potentiometer down.

Not Working

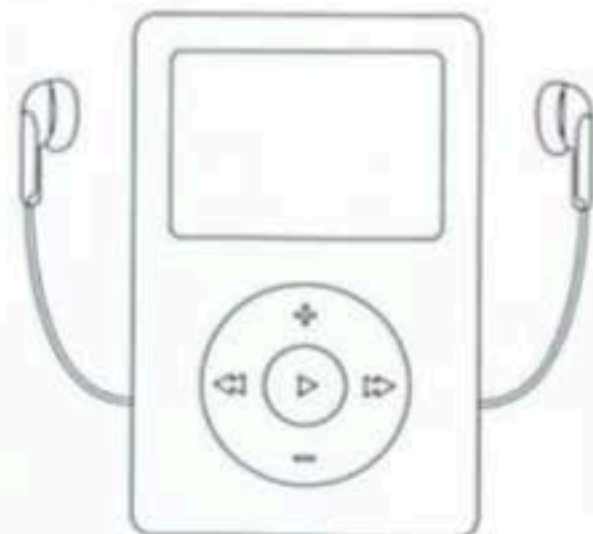
Make sure you haven't accidentally connected the potentiometer's wiper to digital pin 2 rather than analog pin 2. (the row of pins beneath the power pins).

Still Backward

You can try operating the circuit upside down. Sometimes this helps.

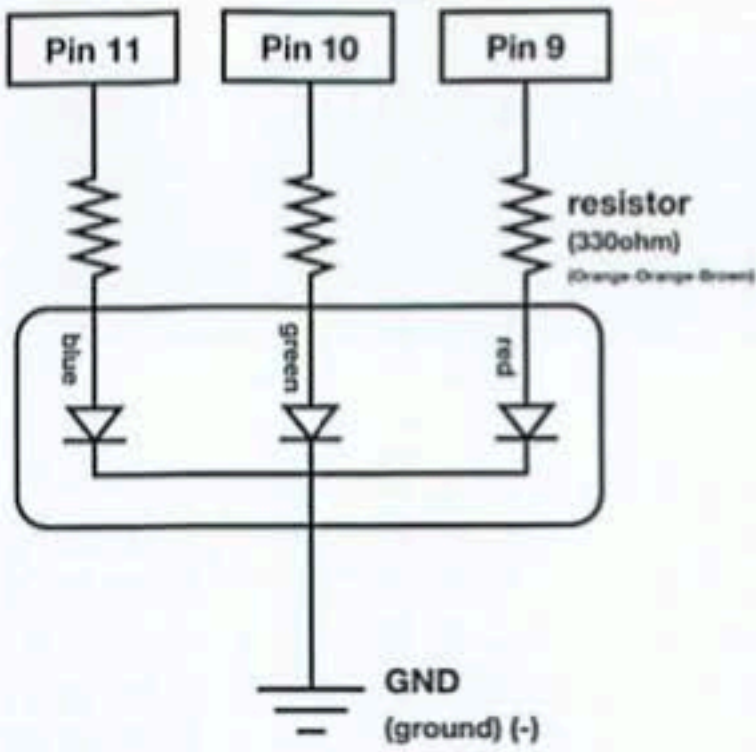
Real World Application:

MP3 players' volume control is an example of a potentiometer in action.

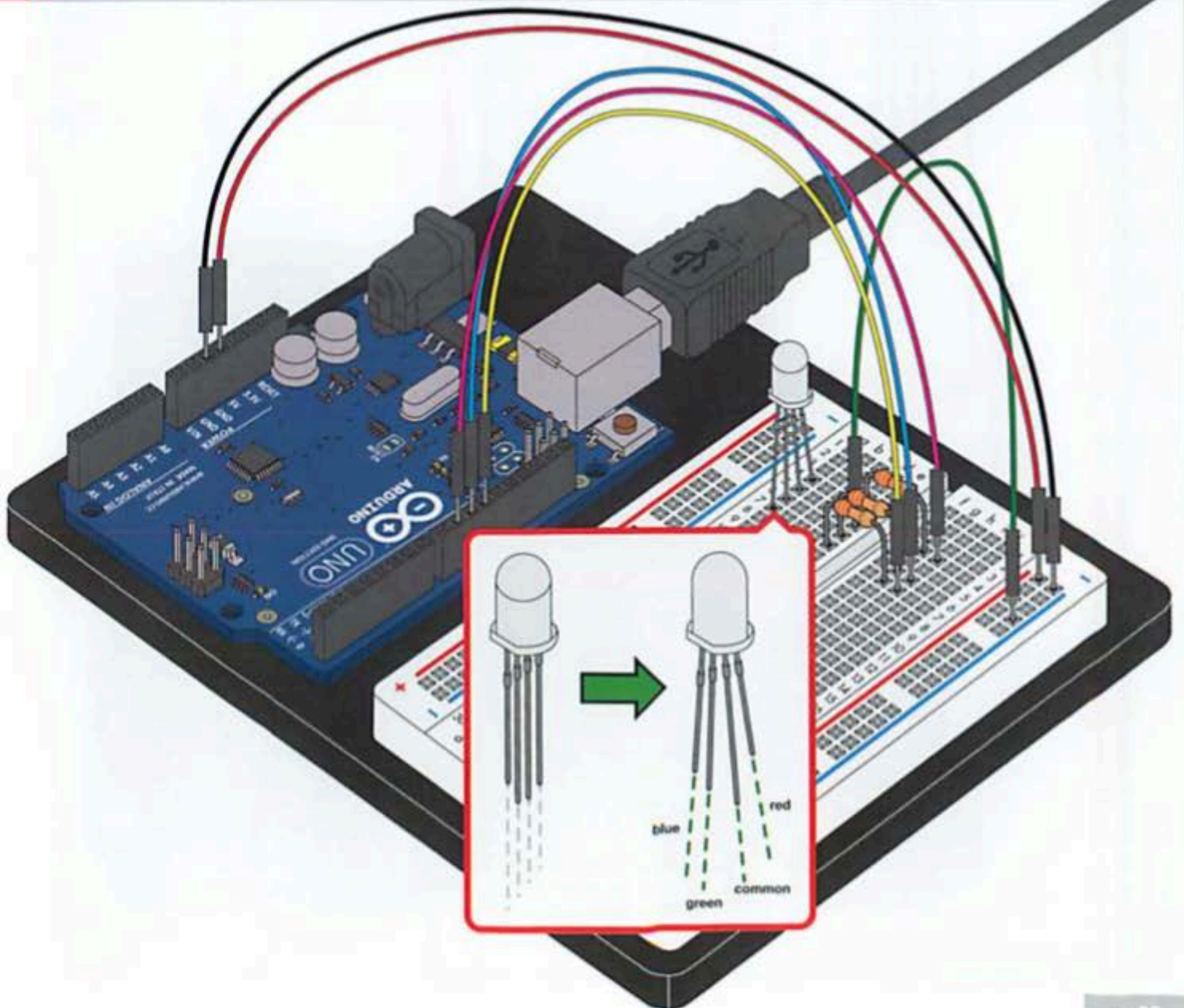


RGB LED

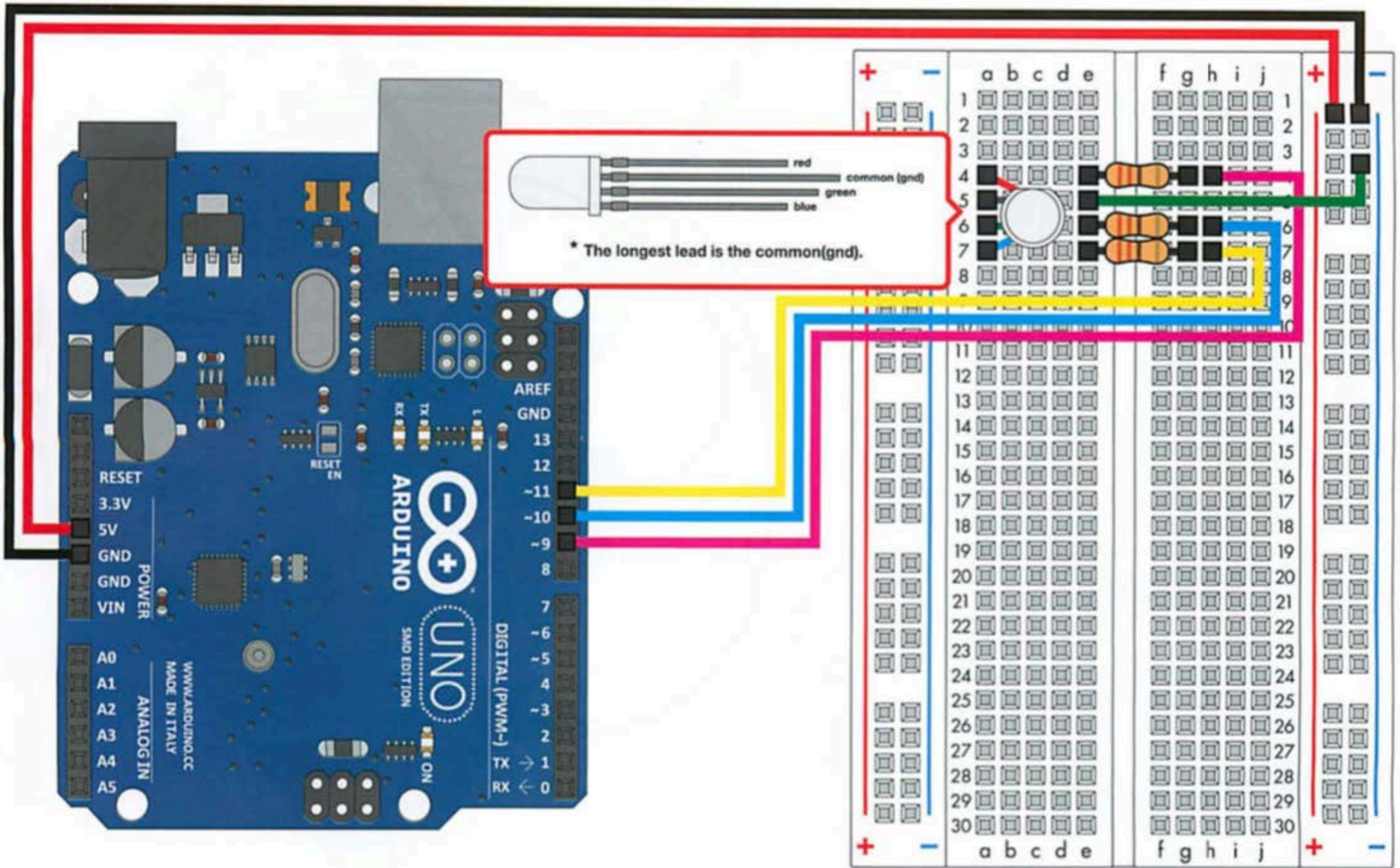
You know what's even more fun than a blinking LED? A colored one. RGB, or red-green-blue, LEDs have three different color-emitting diodes that can be combined to create all sorts of colors. In this circuit, you'll learn how to use an RGB LED to create unique color combinations. Depending on how bright each diode is, nearly any color is possible!












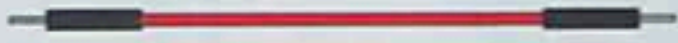



- PARTS:**
- LED x1
 - 330Ω Resistor x3
 - Wire x6



Circuit 3: RGB LED



Component:	Image Reference:		
RGB LED (5mm) 			
330Ω Resistor			e4 - g4
330Ω Resistor			e6 - g6
330Ω Resistor			e7 - g7
Jumper Wire		Pin 9	h4
Jumper Wire			e5 - -
Jumper Wire		Pin 10	h6
Jumper Wire		Pin 11	h7
Jumper Wire		5V	+
Jumper Wire		GND	-

The shocking truth behind analogWrite():

We've seen that the Arduino can read analog voltages (voltages between 0 and 5 Volts) using the `analogRead()` function. Is there a way for the Arduino to output analog voltages as well?

The answer is no... and yes. The Arduino does not have a true analog voltage output. But, because the Arduino is so fast, it can fake it using something called PWM ("Pulse-Width Modulation").

The Arduino is so fast that it can blink a pin on and off almost 1000 times per second. PWM goes one step further by varying the amount of time that the blinking pin spends HIGH vs. the time it spends LOW. If it spends most of its time HIGH, a LED connected to that pin will appear bright. If it spends most of its time LOW, the LED will look dim. Because the pin is blinking much faster than your eye can detect, the Arduino creates the illusion of a "true" analog output.





Open Arduino IDE // File > Examples > USK Guide > Circuit # 3

Code to Note:



```
for (x = 0; x < 768; x++)  
||
```



A for() loop is used to step a number across a range, and repeatedly runs code within the brackets {}. Here the variable "x" starts a 0, ends at 767, and increases by one each time ("x++").

```
if (x <= 255)  
||  
else  
||
```



"If / else" statements are used to make choices in your programs. The statement within the parenthesis () is evaluated; if it's true, the code within the first brackets {} will run. If it's not true, the code within the second brackets {} will run.

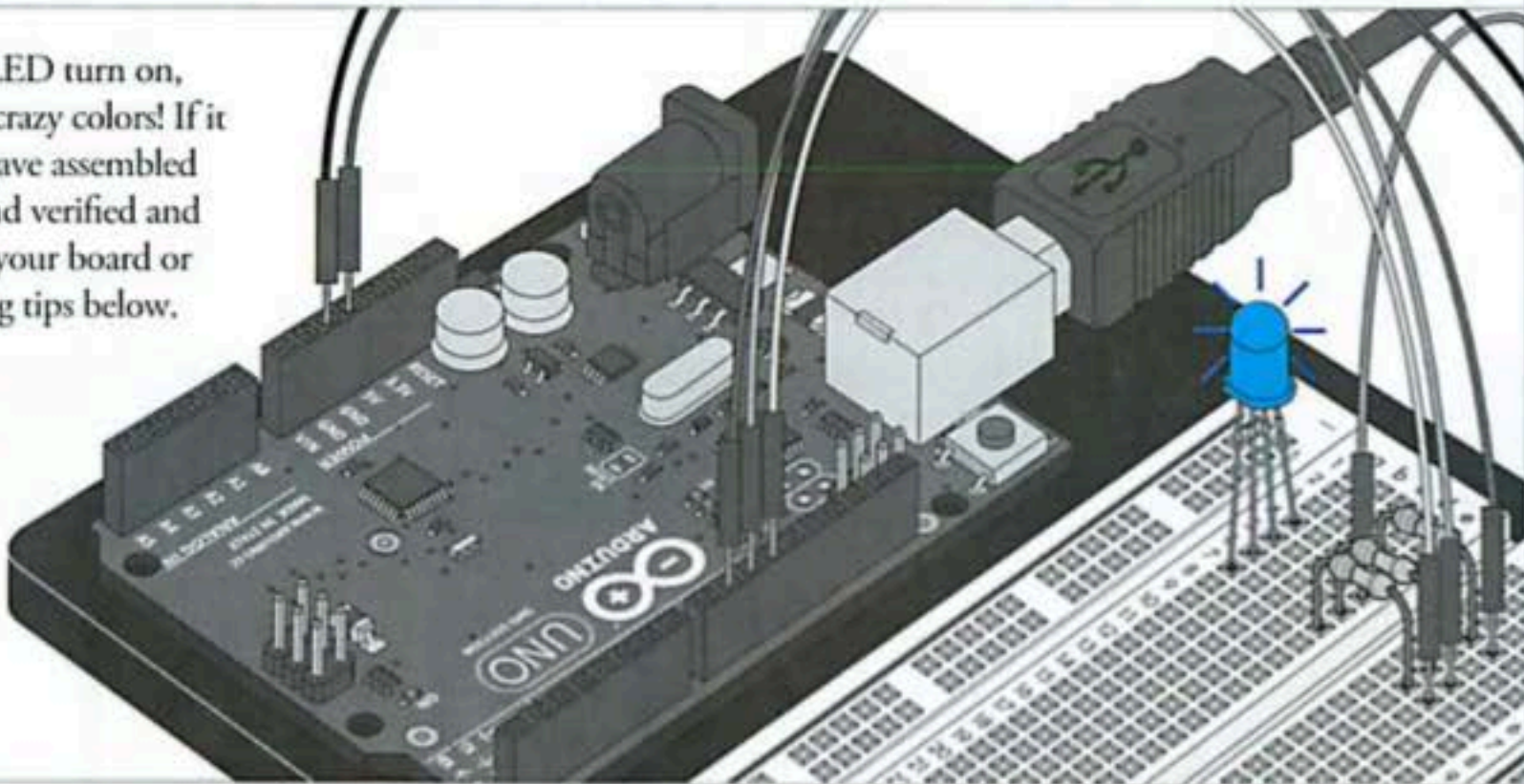
```
delay(sensorValue);
```



The Arduino is very very fast, capable of running thousands of lines of code each second. To slow it down so that we can see what it's doing, we'll often insert delays into the code. Delay() counts in milliseconds; there are 1000 ms in one second.

What you Should See:

You should see your LED turn on, but this time in new, crazy colors! If it isn't, make sure you have assembled the circuit correctly and verified and uploaded the code to your board or see the troubleshooting tips below.



Troubleshooting:

LED Remains Dark or Shows Incorrect Color

With the four pins of the LED so close together, it's sometimes easy to misplace one. Double check each pin is where it should be.

Seeing Red

The red diode within the RGB LED may be a bit brighter than the other two. To make your colors more balanced, use a higher ohm resistor. Or adjust in code.

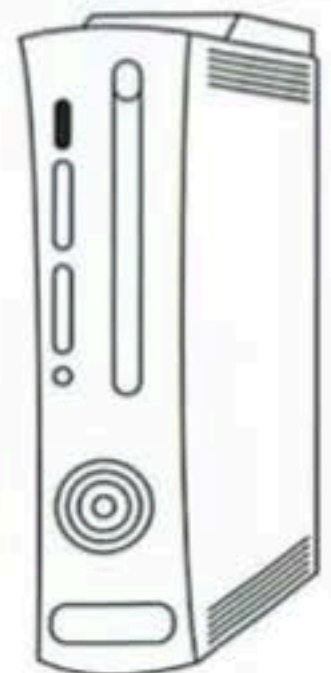
```
analogWrite(RED_PIN, redIntensity);
```

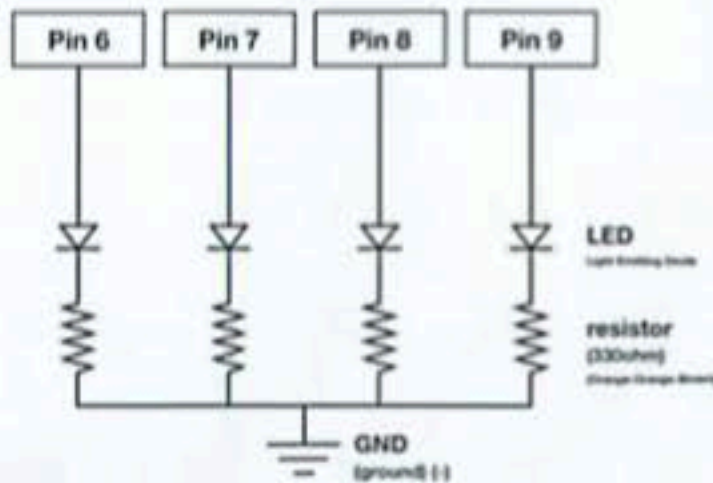
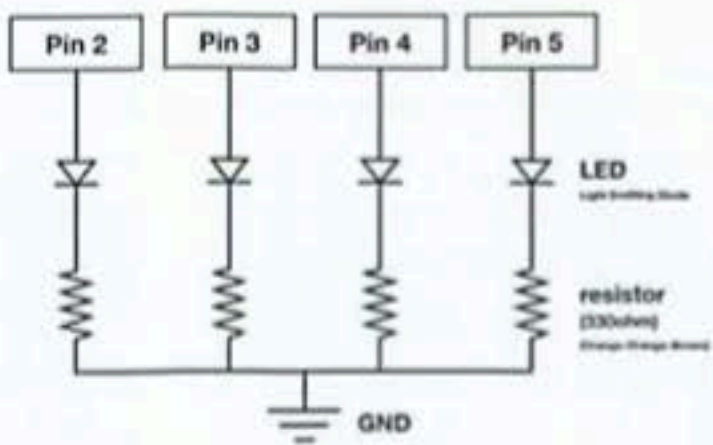
to

```
analogWrite(RED_PIN, redIntensity/3);
```

Real World Application:

Many electronics such as videogame consoles use RGB LEDs to have the versatility to show different colors in the same area. Often times the different colors represent different states of working condition.





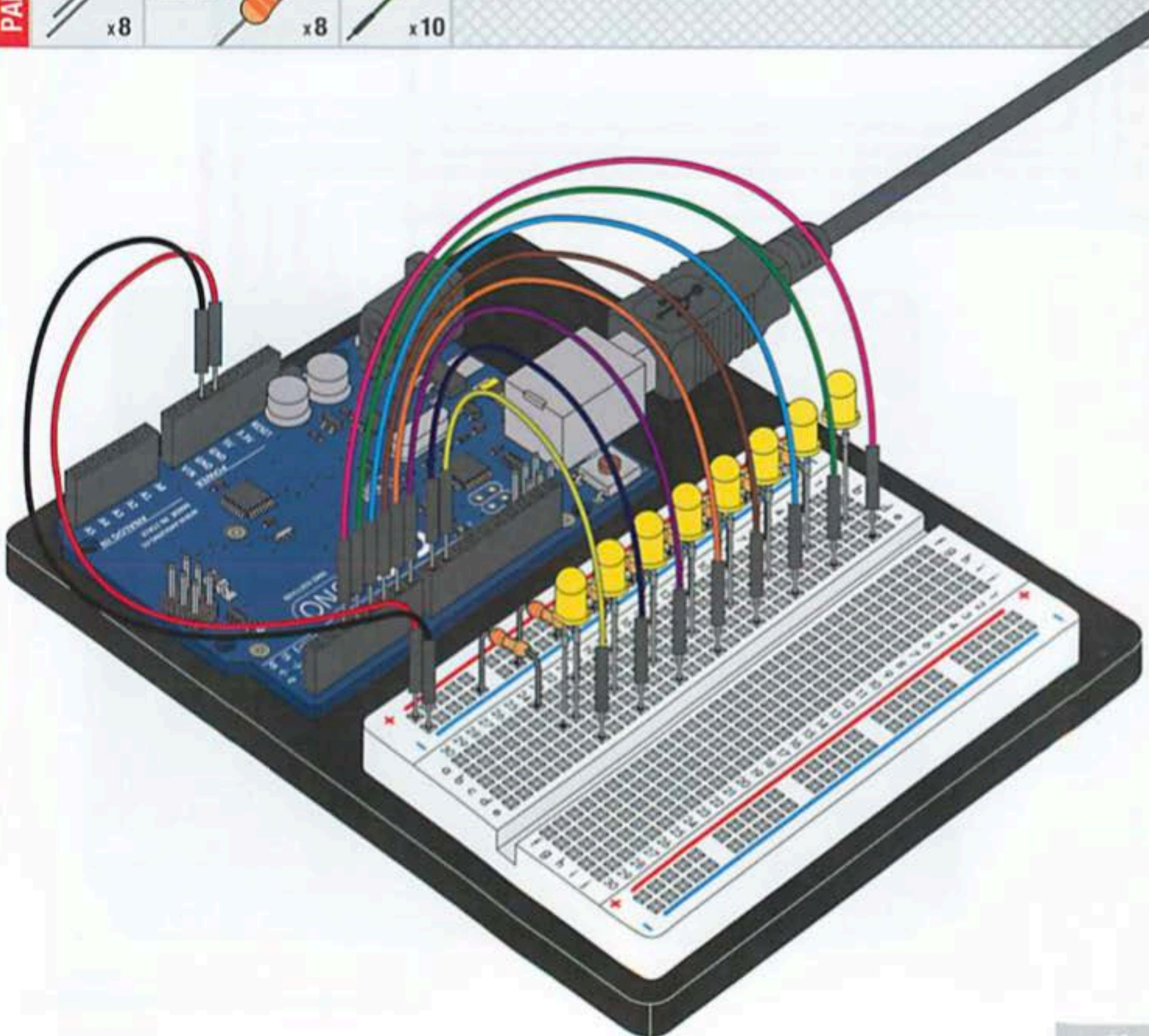
Multiple LEDs

So you have gotten one LED to blink on and off – fantastic! Now it's time to up the stakes a little bit – by connecting EIGHT LEDs AT ONCE. We'll also give our Arduino a little test by creating various lighting sequences. This circuit is a great setup to start practicing writing your own programs and getting a feel for the way Arduino works.

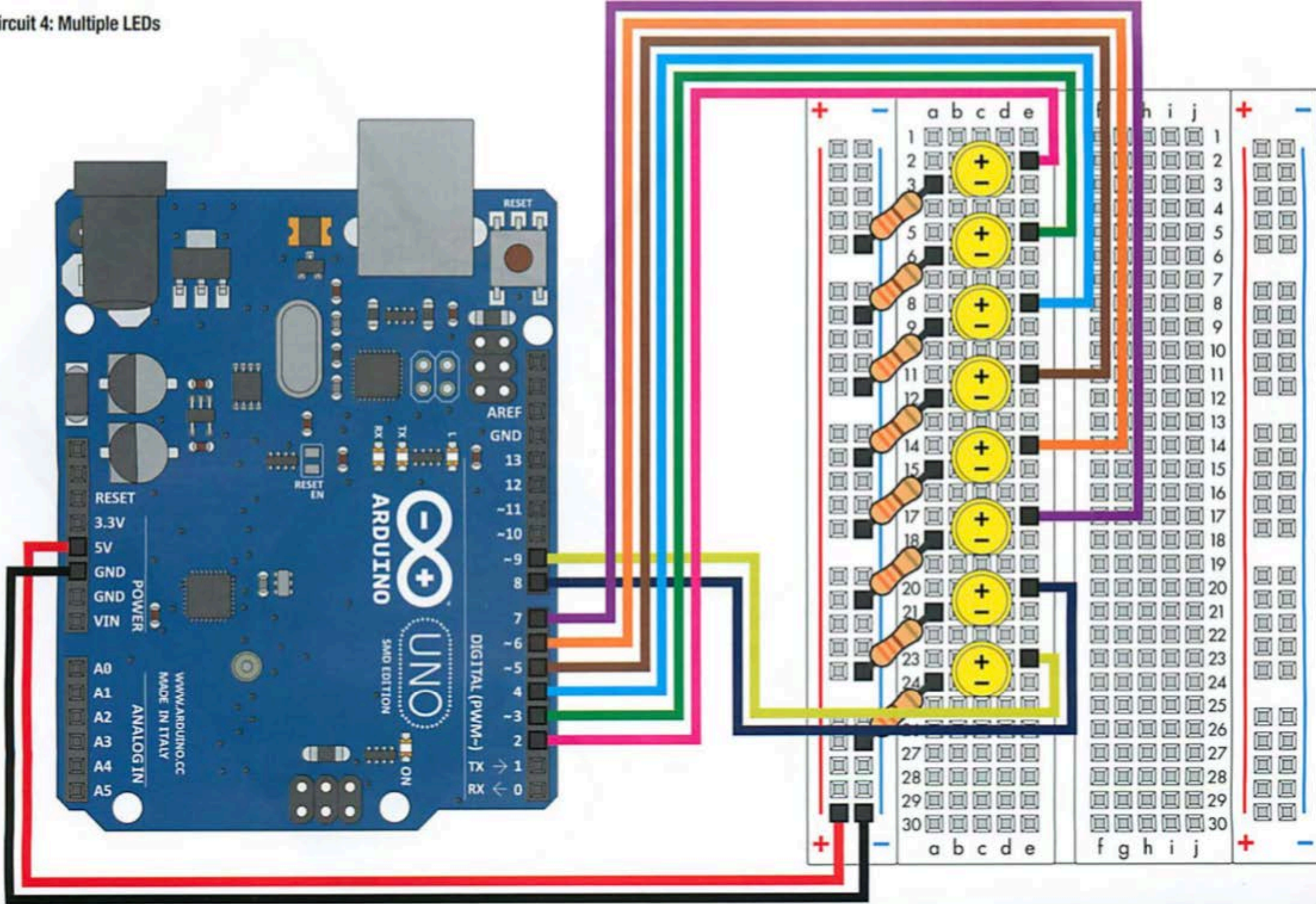
Along with controlling the LEDs, you'll learn about a couple programming tricks that keep your code neat and tidy:










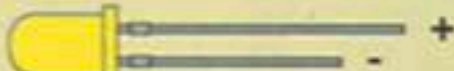
















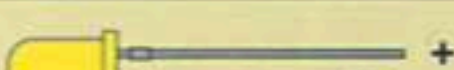










for() loops - used when you want to run a piece of code several times

arrays[] - used to make managing variables easier by grouping them together



Circuit 4: Multiple LEDs



Component:	Image Reference:			Component:	Image Reference:		
LED (5mm) 			c2-c3 + -	330Ω Resistor			GND-a18
LED (5mm) 			c5-c6 + -	330Ω Resistor			GND-a21
LED (5mm) 			c8-c9 + -	330Ω Resistor			GND-a24
LED (5mm) 			c11-c12 + -	Jumper Wire		Pin 2	e2
LED (5mm) 			c14-c15 + -	Jumper Wire		Pin 3	e5
LED (5mm) 			c17-c18 + -	Jumper Wire		Pin 4	e8
LED (5mm) 			c20-c21 + -	Jumper Wire		Pin 5	e11
LED (5mm) 			c23-c24 + -	Jumper Wire		Pin 6	e14
330Ω Resistor		GND	a3	Jumper Wire		Pin 7	e17
330Ω Resistor		GND	a6	Jumper Wire		Pin 8	e20
330Ω Resistor		GND	a9	Jumper Wire		Pin 9	e23
330Ω Resistor		GND	a12	Jumper Wire		Pin 3	+
330Ω Resistor		GND	a15	Jumper Wire		GND	-

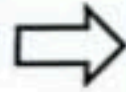


Open Arduino IDE // File > Examples > USK Guide > Circuit # 4

Code to Note:

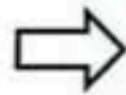


```
int ledPins[] = {2,3,4,5,6,7,8,9};
```



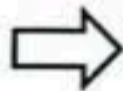
When you have to manage a lot of variables, an "array" is a handy way to group them together. Here we're creating an array of integers, called ledPins, with eight elements.

```
digitalWrite(ledPins[0], HIGH);
```



You refer to the elements in an array by their position. The first element is at position 0, the second is at position 1, etc. You refer to an element using "ledPins[x]" where x is the position. Here we're making digital pin 2 HIGH, since the array element at position 0 is "2".

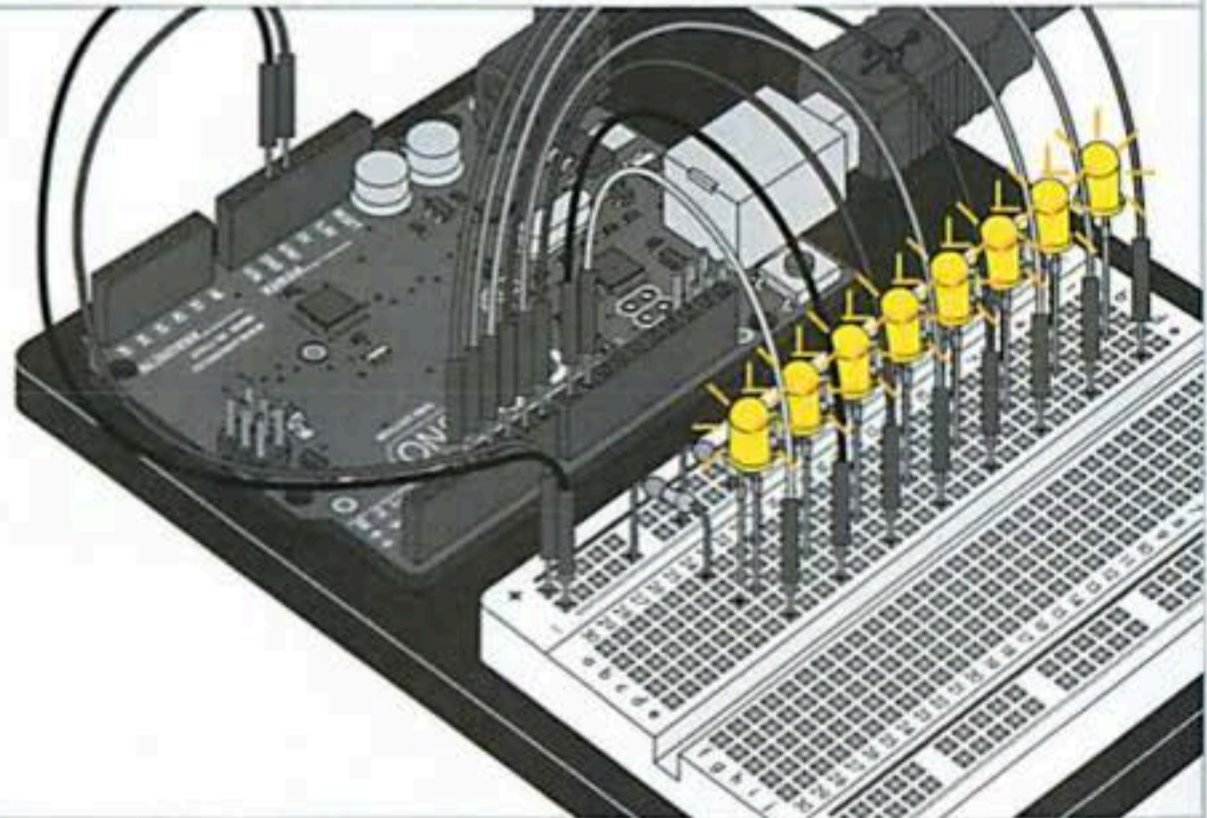
```
index = random(8);
```



Computers like to do the same things each time they run. But sometimes you want to do things randomly, such as simulating the roll of a dice. The random() function is a great way to do this. See <http://arduino.cc/en/Reference/Random> for more information.

What you Should See:

This is similar to circuit number one, but instead of one LED, you should see all the LEDs blink. If they aren't, make sure you have assembled the circuit correctly and verified and uploaded the code to your board or see the troubleshooting tips below.



Troubleshooting:

Some LEDs Fail to Light

It is easy to insert an LED backwards. Check the LEDs that aren't working and ensure they are the right way around.

Operating out of sequence

With eight wires it's easy to cross a couple. Double check that the first LED is plugged into pin 2 and each pin thereafter.

Starting Afresh

It's easy to accidentally misplace a wire without noticing. Pulling everything out and starting with a fresh slate is often easier than trying to track down the problem.

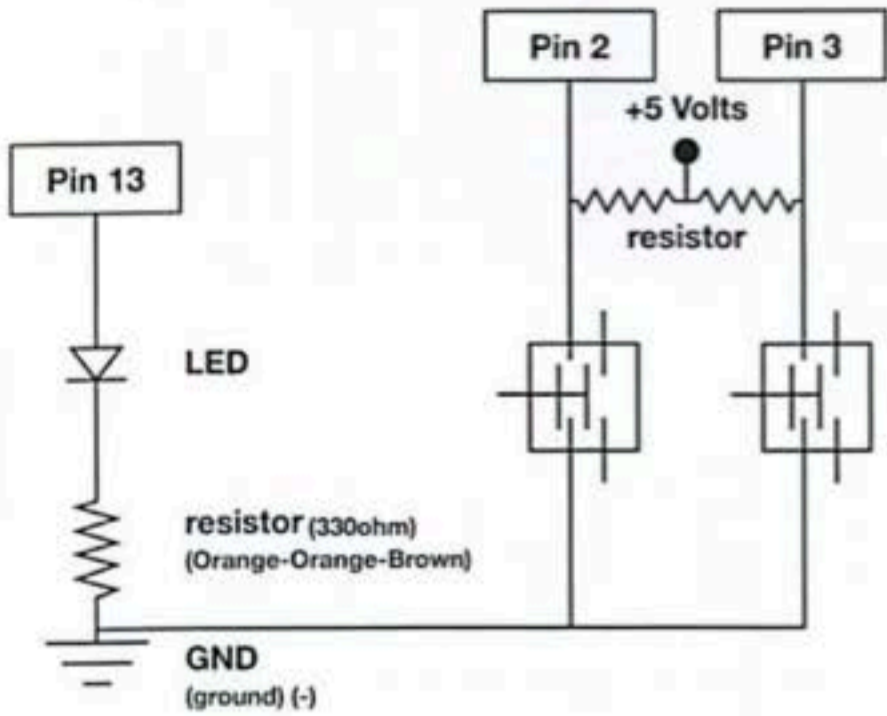
Real World Application:

Scrolling marquee displays are generally used to spread short segments of important information. They are built out of many LEDs.



Push Buttons

Up until now, we've focused solely on outputs. Now we're going to go to the other end of spectrum and play around with inputs. In this circuit, we'll be looking at one of the most common and simple inputs – a push button. The way a push button works with Arduino is that when the button is pushed, the voltage goes LOW. The Arduino reads this and reacts accordingly. In this circuit, you will also use a pull-up resistor, which helps clean up the voltage and prevents false readings from the button.



PARTS:

Push Button



x2

LED



x1

10KΩ Resistor



x2

330Ω Resistor

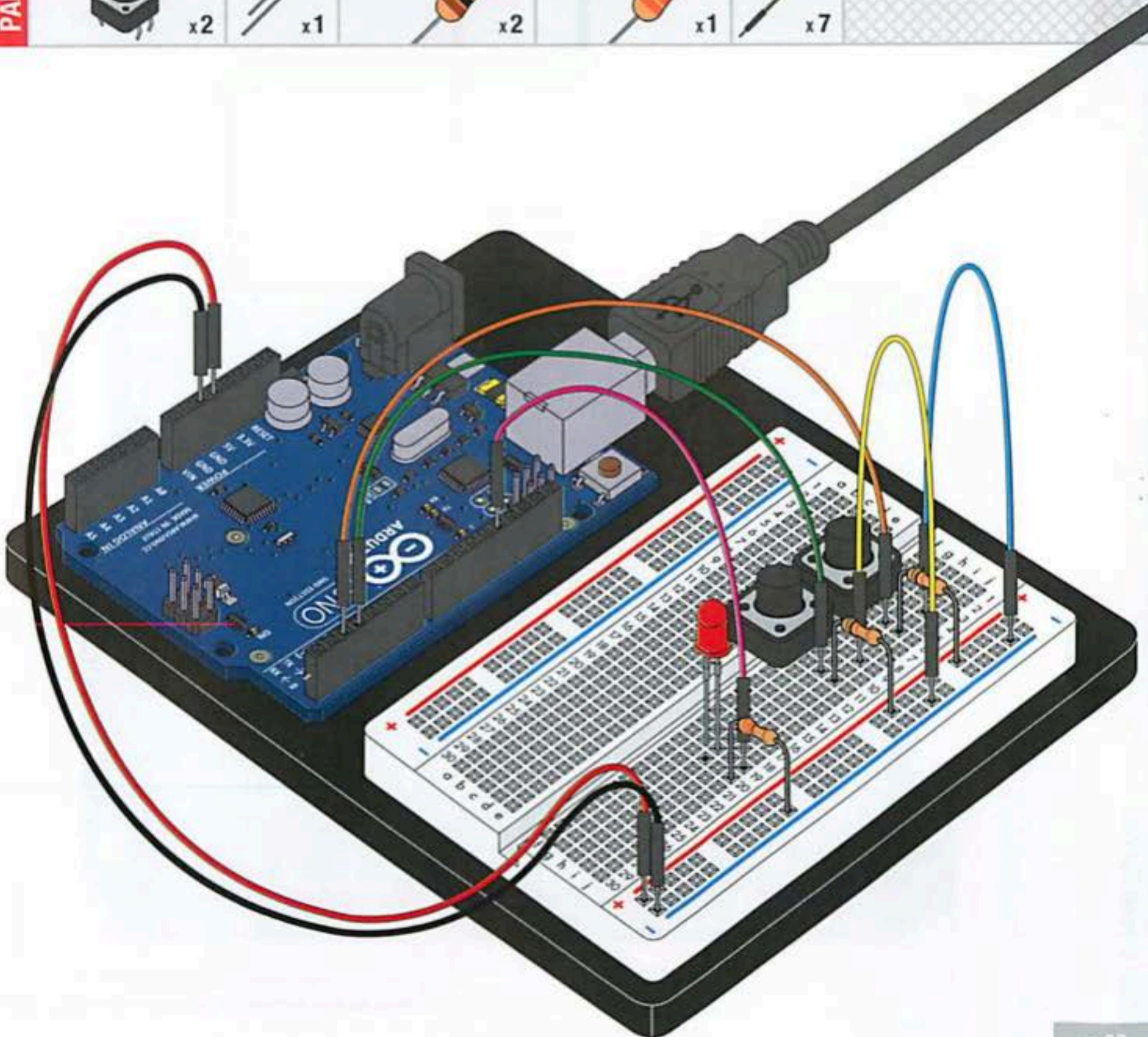

















x1

Wire



x7



Component:	Image Reference:		
Push Button			d4 g4 d6 g6
Push Button			d9 g9 d11 g11
LED (5mm) 			h20-h21 + -
10KΩ Resistor			i6 +
10KΩ Resistor			i11 +
330Ω Resistor			j21 -
Jumper Wire			i4 -
Jumper Wire			i9 -
Jumper Wire			Pin 2 h6
Jumper Wire			Pin 3 h11
Jumper Wire		Pin 13 j20	

How to use logic like a Vulcan:

One of the things that makes the Arduino so useful is that it can make complex decisions based on the input it's getting. For example, you could make a thermostat that turns on a heater if it gets too cold, a fan if it gets too hot, waters your plants if they get too dry, etc.

In order to make such decisions, the Arduino provides a set of logic operations that let you build complex "if" statements. They include:

Symbol	Operation	Description
==	EQUIVALENCE	A == B is true if A and B are the SAME .
!=	DIFFERENCE	A != B is true if A and B are NOT THE SAME .
&&	AND	A && B is true if BOTH A and B are TRUE .
	OR	A B is true if A or B or BOTH are TRUE .
!	NOT	!A is TRUE if A is FALSE , and FALSE if A is TRUE .

You can combine these functions to build complex if() statements.

For example:

```
if ((mode == heat) && ((temperature < threshold) || (override == true)))
{
digitalWrite(HEATER, HIGH);
}
```

...will turn on a heater if you're in heating mode **AND** the temperature is low, **OR** if you turn on a manual override. Using these logic operators, you can program your Arduino to make intelligent decisions and take control of the world around it!

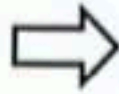


Open Arduino IDE // File > Examples > USK Guide > Circuit # 5

Code to Note:



`pinMode(button2Pin, INPUT);`



The digital pins can be used as inputs as well as outputs. Before you do either, you need to tell the Arduino which direction you're going.

`button1State = digitalRead(button1Pin);`



To read a digital input, you use the `digitalRead()` function. It will return HIGH if there's 5V present at the pin, or LOW if there's 0V present at the pin.

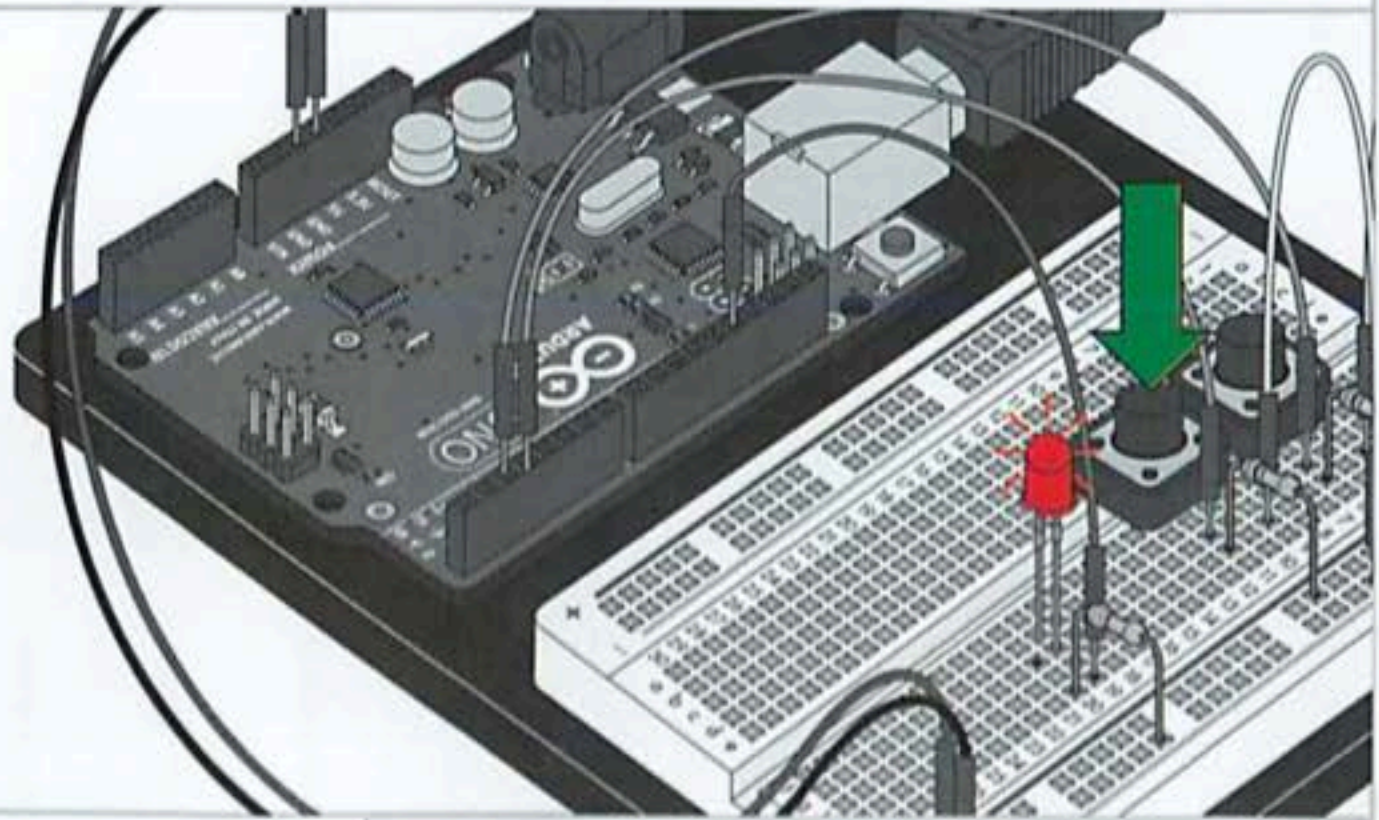
`if (button1State == LOW)`



Because we've connected the button to GND, it will read LOW when it's being pressed. Here we're using the "equivalence" operator ("==") to see if the button is being pressed.

What You Should See:

You should see the LED turn on and off as you press the button. If it isn't working, make sure you have assembled the circuit correctly and verified and uploaded the code to your board or see the troubleshooting tips below.



Troubleshooting:

Light Not Turning On

The pushbutton is square, and because of this it is easy to put it in the wrong way. Give it a 90 degree twist and see if it starts working.

Light Not Fading

A bit of a silly mistake we constantly made, when you switch from simple on off to fading, remember to move the LED wire from pin 13 to pin 9.

Underwhelmed

No worries, these circuits are all super stripped down to make playing with the components easy, but once you throw them together the sky is the limit.

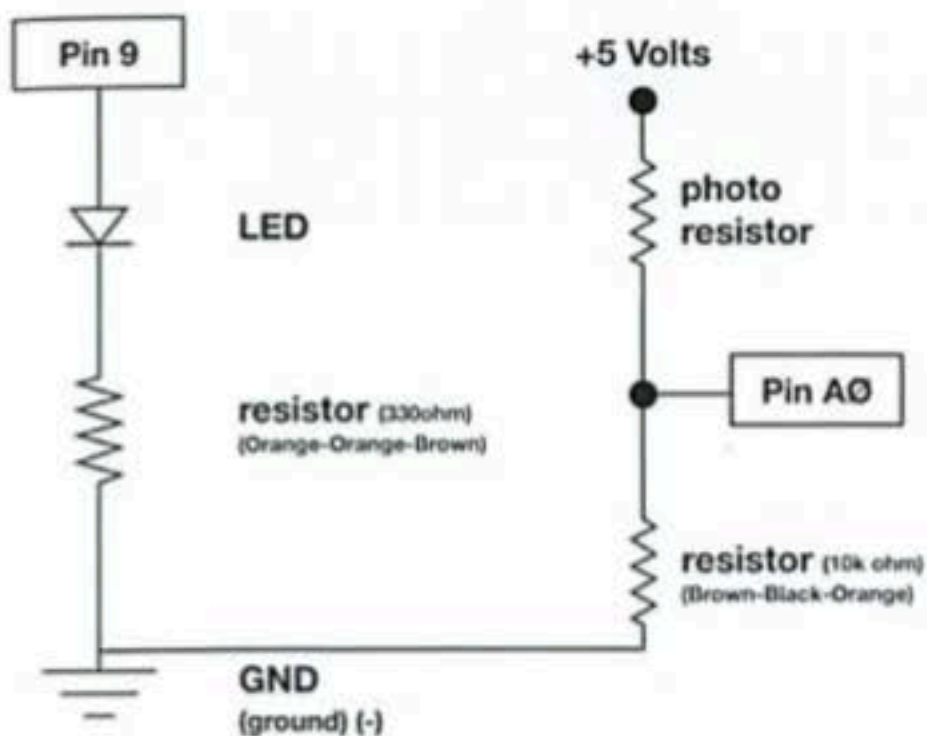
Real World Application:

The buttons we used here are similar to the buttons in most videogame controllers.

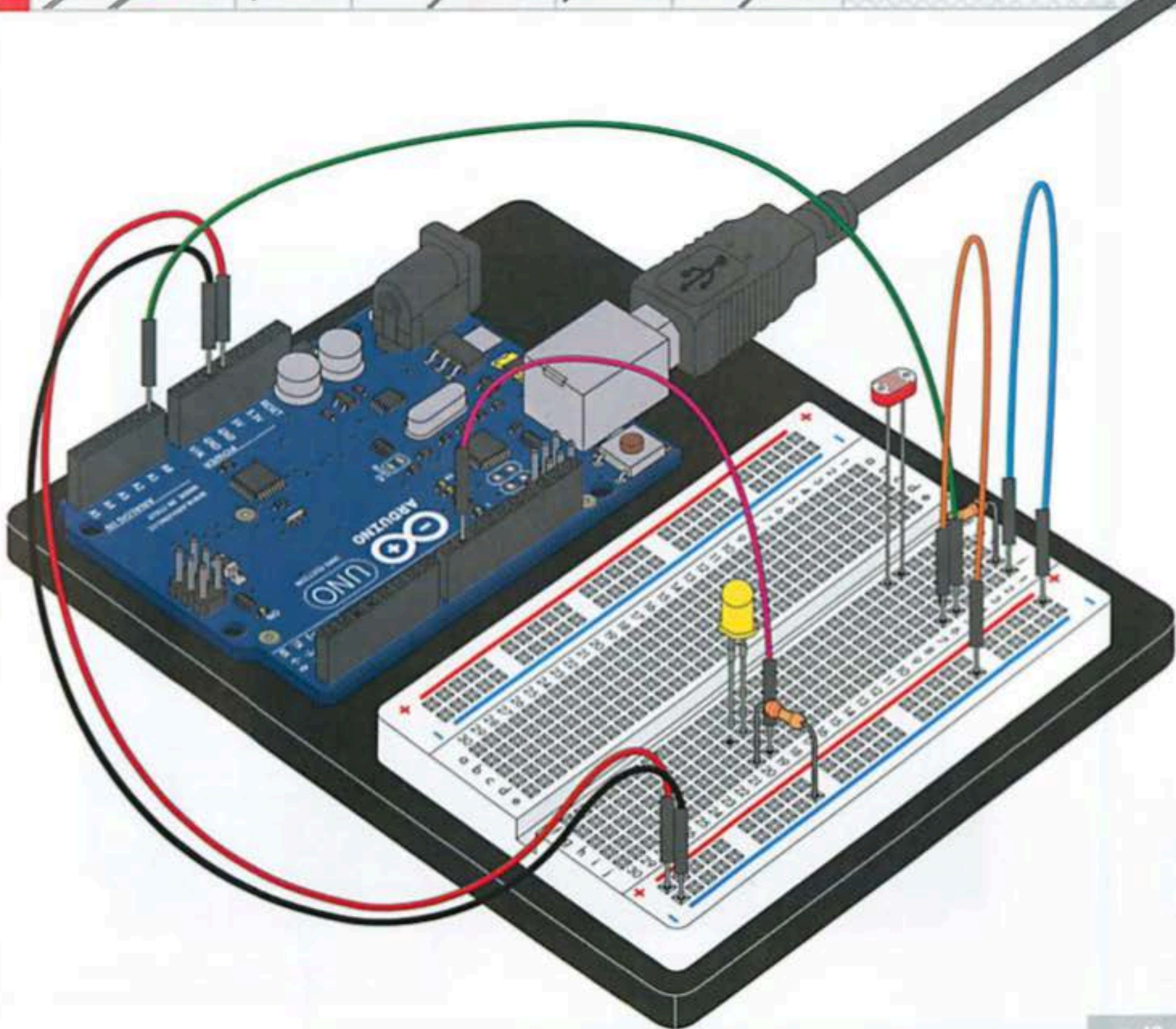














Photo Resistor

So you've already played with a potentiometer, which varies resistance based on the twisting of a knob. In this circuit, you'll be using a photo resistor, which changes resistance based on how much light the sensor receives. Since the Arduino can't directly interpret resistance (rather it reads voltage), we use a voltage divider to use our photo resistor. This voltage divider will output a high voltage when it is getting a lot of light and a low voltage when it is not.



PARTS:

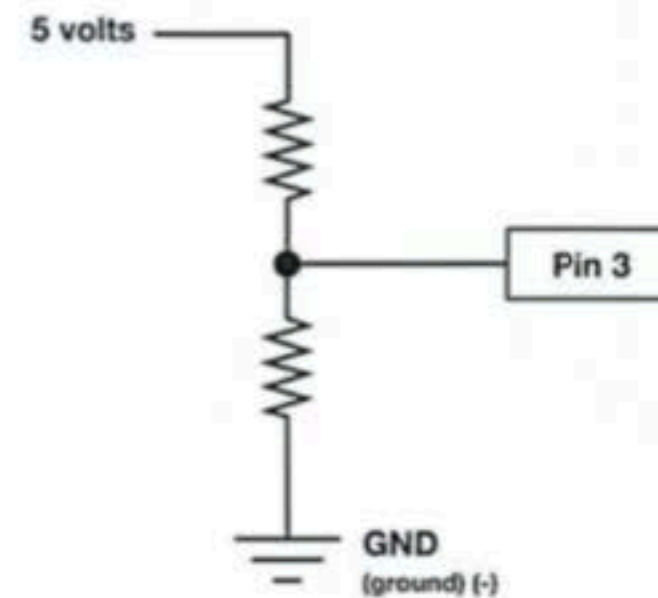


Component:	Image Reference:		
Photo Resistor			
LED (5mm)			
330Ω Resistor (sensor)			
10KΩ Resistor			
Jumper Wire			
Jumper Wire		A0	j5
Jumper Wire			j6 -
Jumper Wire		Pin 9	j20
Jumper Wire		5V	+
Jumper Wire		GND	-

Measuring resistive sensors:

Many of the sensors you'll use (potentiometers, photoresistors, etc.) are resistors in disguise. Their resistance changes in proportion to whatever they're sensing (light level, etc.).

The Arduino's analog input pins measure voltage, not resistance. But we can easily use resistive sensors with the Arduino by including them as part of a "voltage divider".



A voltage divider consists of two resistors. The "top" resistor is the sensor you'll be using. The "bottom" one is a normal, fixed resistor. When you connect the top resistor to 5 Volts, and the bottom resistor to ground, the middle will output a voltage proportional to the values of the two resistors. When one of the resistors changes (as it will when your sensor senses things), the output voltage will change as well!

Although the sensor's resistance will vary, the resistive sensors (flex sensor, light sensor, softpot, and trimpot) in the USK are around 10K Ohms. We usually want the fixed resistor to be close to this value, so using a 10K resistor is a great choice for the fixed "bottom" resistor.



Open Arduino IDE // File > Examples > USK Guide > Circuit # 6

Code to Note:



➔ When we read an analog signal using `analogRead()`, it will be a number from 0 to 1023. But when we want to drive a PWM pin using `analogWrite()`, it wants a number from 0 to 255. We can "squeeze" the larger range into the smaller range using the `map()` function.

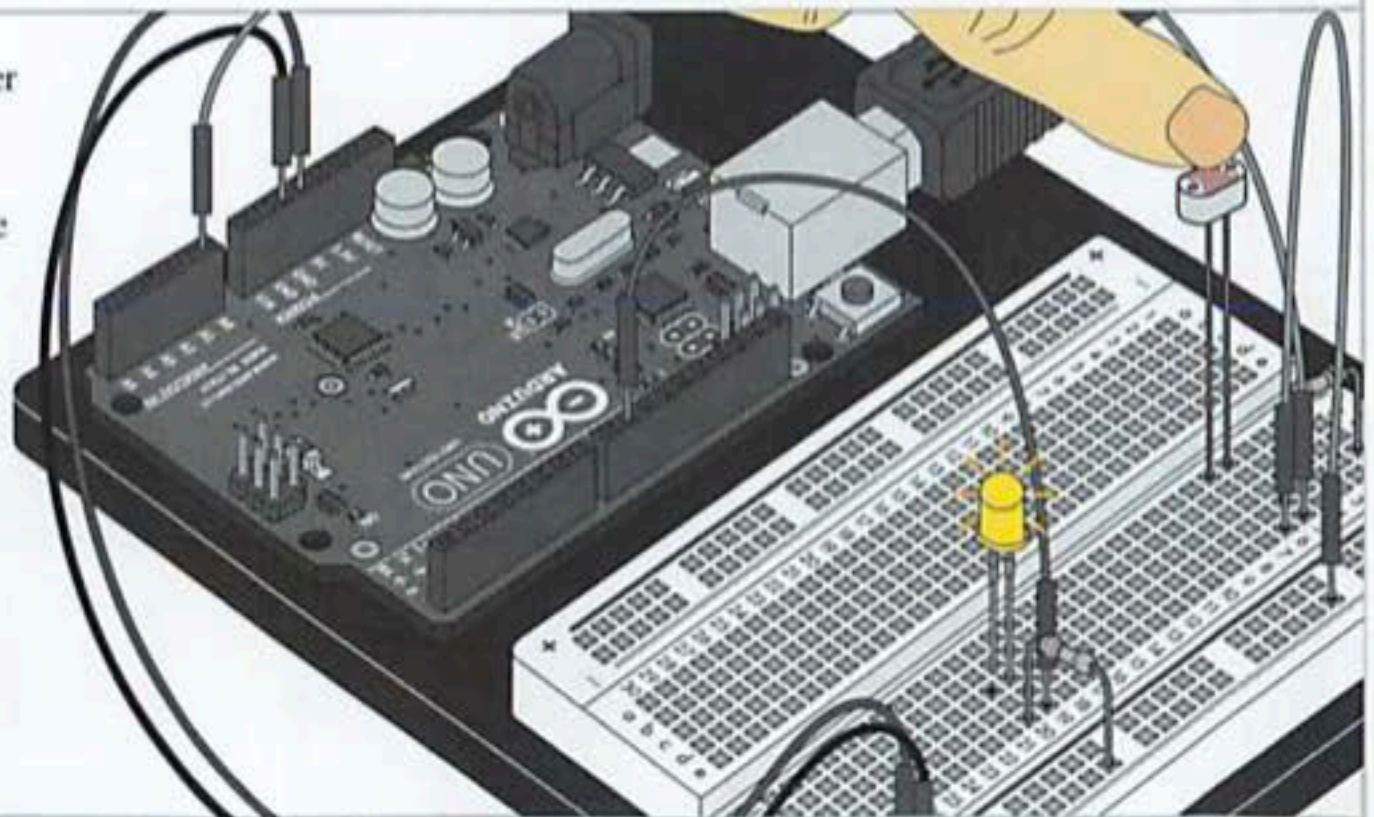
```
lightLevel = map(lightLevel, 0, 1023, 0, 255);
```

➔ Because `map()` could still return numbers outside the "to" range, we'll also use a function called `constrain()` that will "clip" numbers into a range. If the number is outside the range, it will make it the largest or smallest number. If it is within the range, it will stay the same.

```
lightLevel = constrain(lightLevel, 0, 255);
```

What You Should See:

You should see the LED grow brighter or dimmer in accordance with how much light your photoresistor is reading. If it isn't working, make sure you have assembled the circuit correctly and verified and uploaded the code to your board or see the troubleshooting tips below.



Troubleshooting:

LED Remains Dark

This is a mistake we continue to make time and time again, if only they could make an LED that worked both ways. Pull it up and give it a twist.

It Isn't Responding to Changes in Light

Given that the spacing of the wires on the photo-resistor is not standard, it is easy to misplace it. Double check it's in the right place.

Still Not Quite Working

You may be in a room which is either too bright or dark. Try turning the lights on or off to see if this helps. Or if you have a flashlight near by give that a try.

Real World Application:

A street lamp uses a light sensor to detect when to turn the lights on at night.

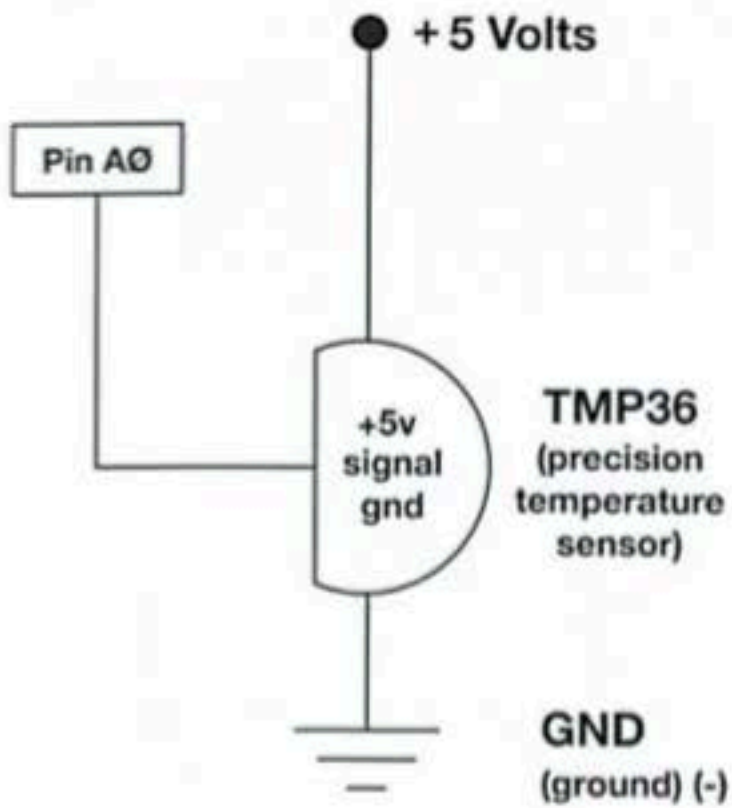


Temperature Sensor

A temperature sensor is exactly what it sounds like – a sensor used to measure ambient temperature. This particular sensor has three pins – a positive, a ground, and a signal. For every centigrade degree it reads, it outputs 10 millivolts. In this circuit, you'll learn how to integrate the temperature sensor with your Arduino, and use the Arduino IDE's debug window to display the temperature.



When you're building the circuit be careful not to mix up the temperature sensor and the transistor, they're almost identical.



PARTS:

Temp. Sensor

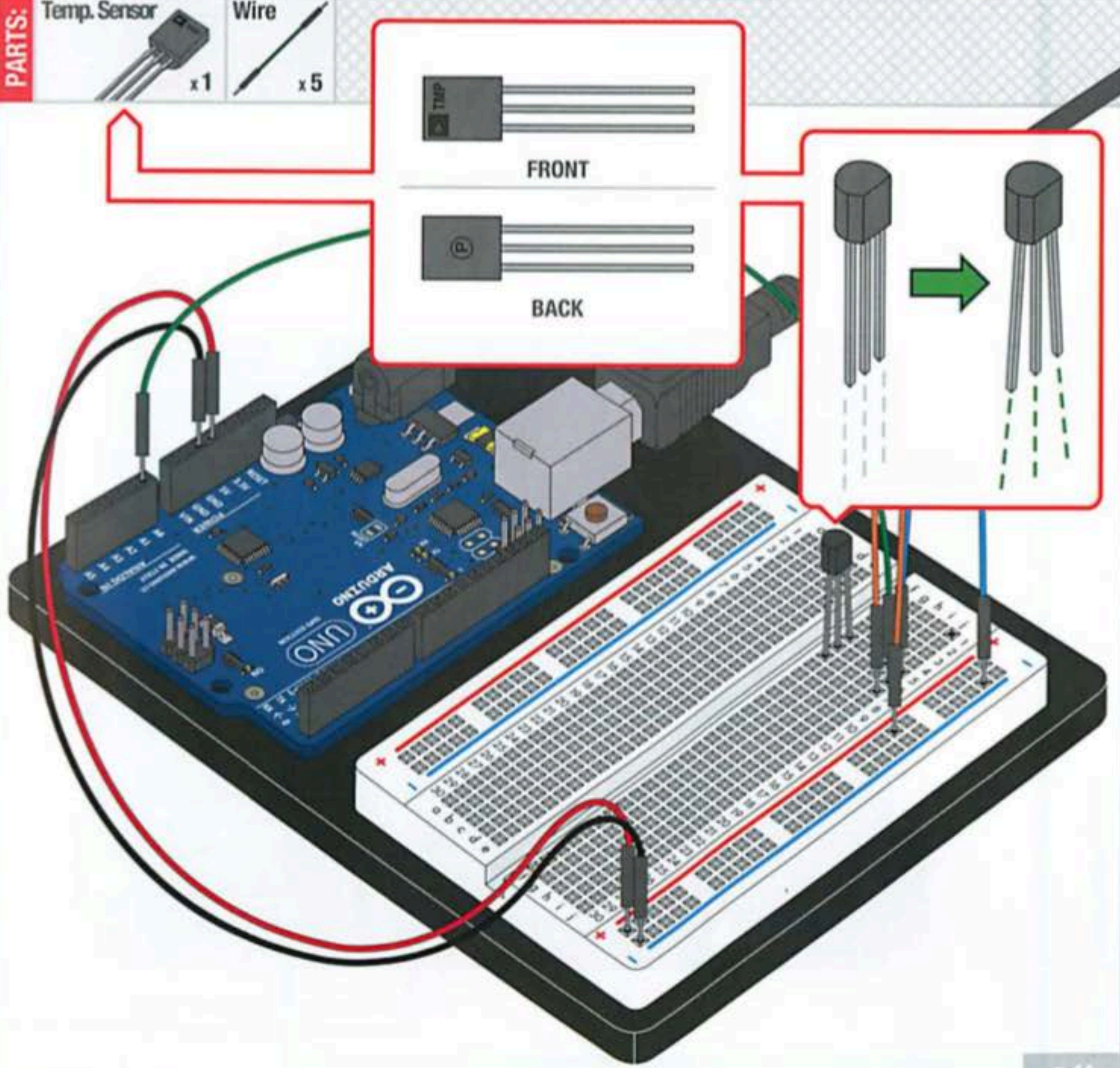


x1

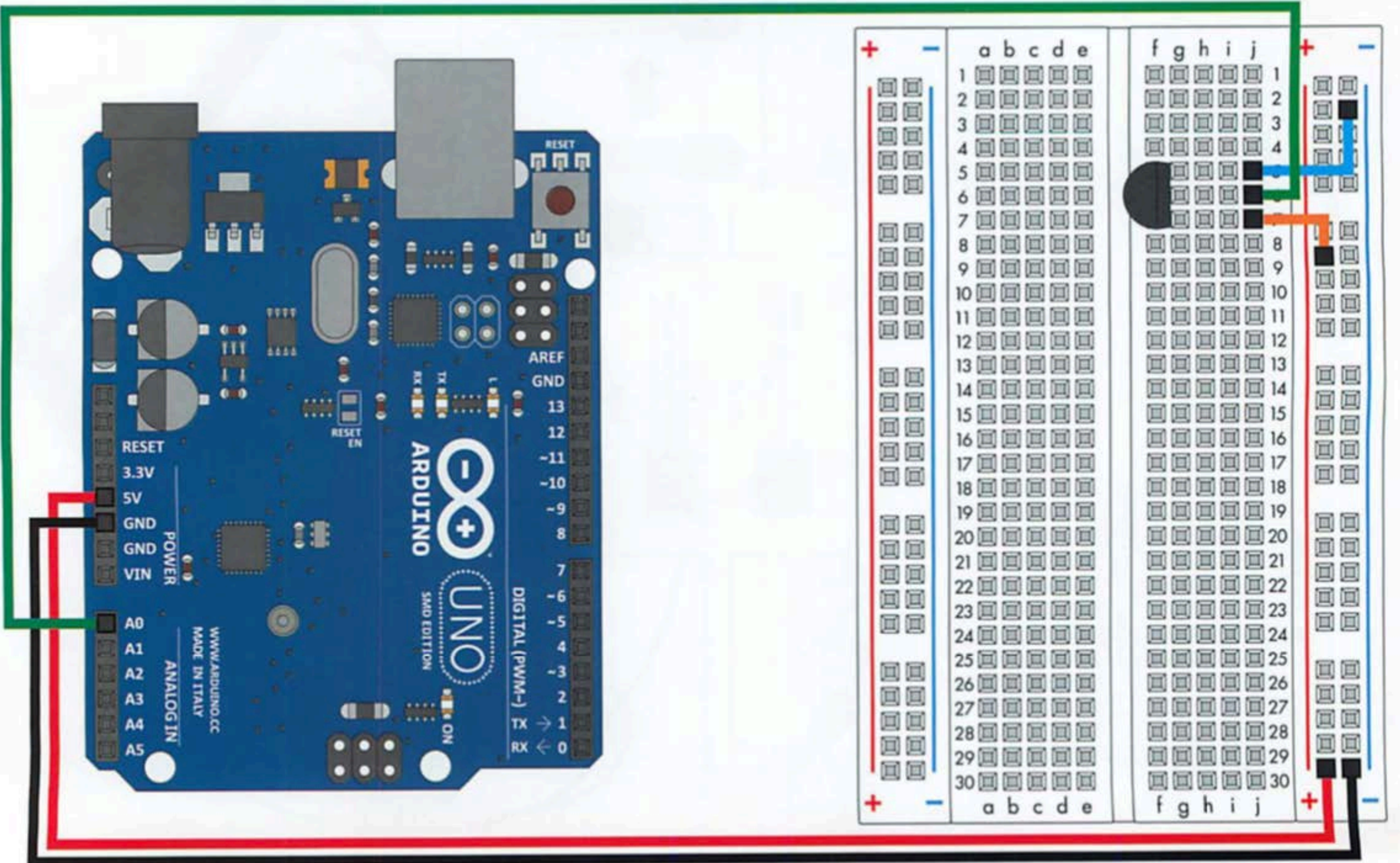
Wire




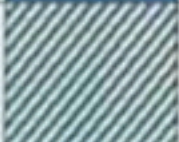









x5



Circuit 7: Temperature Sensor



Component:	Image Reference:		
Temperature Sensor			i5 i6 i7
Jumper Wire			i5 -
Jumper Wire		A0	i6
Jumper Wire			i7 +
Jumper Wire		5V	+
Jumper Wire		GND	-

Opening your serial monitor:

This circuit uses the Arduino IDE's **serial monitor**. To open this, first upload the program then click the button which looks like a magnifying glass in a square.





Open Arduino IDE // File > Examples > USK Guide > Circuit # 7

Code to Note:



`Serial.begin(9600);`



Before using the serial monitor, you must call `Serial.begin()` to initialize it. 9600 is the "baud rate", or communications speed. When two devices are communicating with each other, both must be set to the same speed.

`Serial.print(degreesC);`



The `Serial.print()` command is very smart. It can print out almost anything you can throw at it, including variables of all types, quoted text (AKA "strings"), etc.

See <http://arduino.cc/en/Serial/Print> for more info.

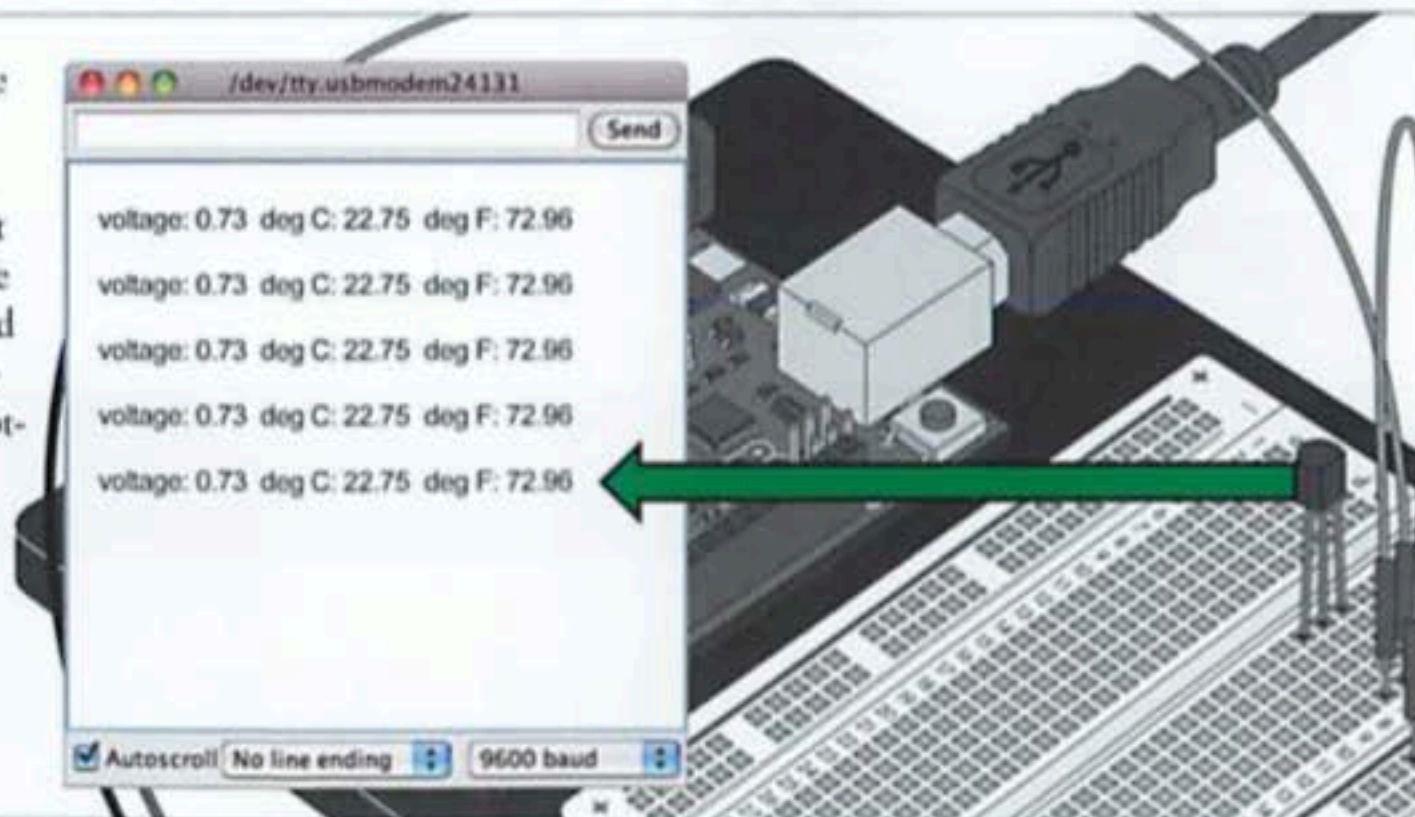
`Serial.println(degreesF);`



`Serial.print()` will print everything on the same line. `Serial.println()` will move to the next line. By using both of these commands together, you can create easy-to-read printouts of text and data.

What You Should See:

You should see be able to read the temperature your temperature sensor is detecting on the serial monitor in the Arduino IDE. If it isn't working, make sure you have assembled the circuit correctly and verified and uploaded the code to your board or see the troubleshooting tips below.



Troubleshooting:

Nothing Seems to Happen

This program has no outward indication it is working. To see the results you must open the Arduino IDE's serial monitor (instructions on previous page).

Gibberish is Displayed

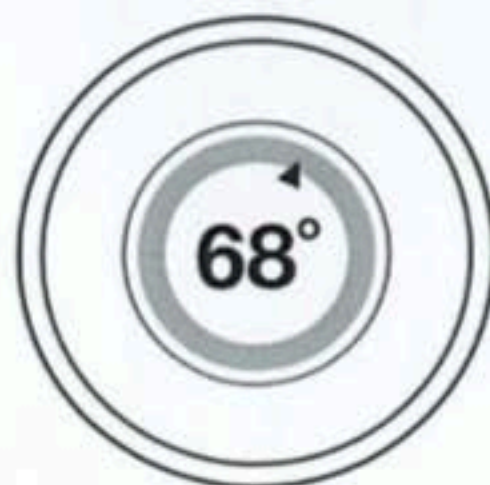
This happens because the serial monitor is receiving data at a different speed than expected. To fix this, click the pull-down box that reads "*** baud" and change it to "9600 baud".

Temperature Value is Unchanging

Try pinching the sensor with your fingers to heat it up or pressing a bag of ice against it to cool it down.

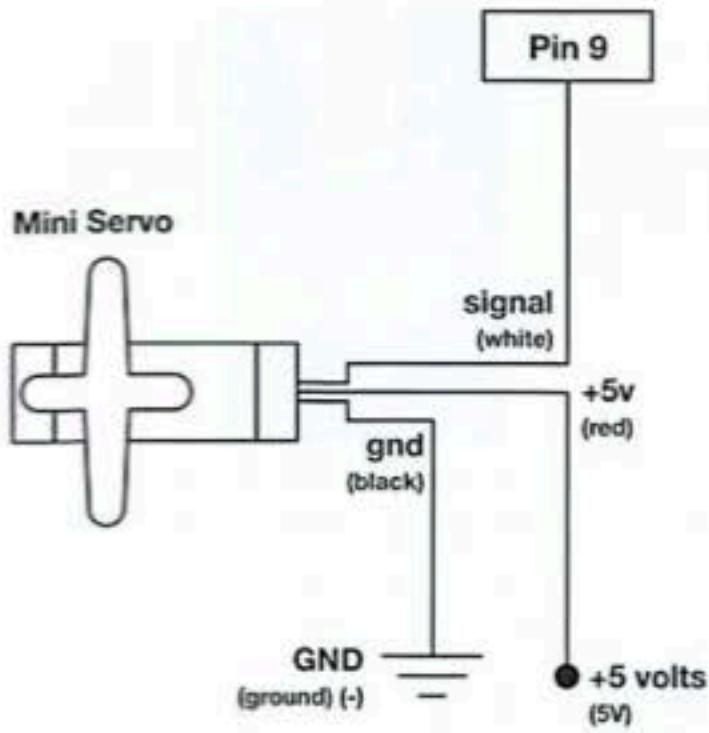
Real World Application:

Building climate control systems use a temperature sensor to monitor and maintain their settings.



A Single Servo

Servos are ideal for embedded electronics applications because they do one thing very well that spinning motors cannot – they can move to a position accurately. By varying the pulse of voltage a servo receives, you can move a servo to a specific position. For example, a pulse of 1.5 milliseconds will move the servo 90 degrees. In this circuit, you'll learn how to use PWM (pulse width modulation) to control and rotate a servo.

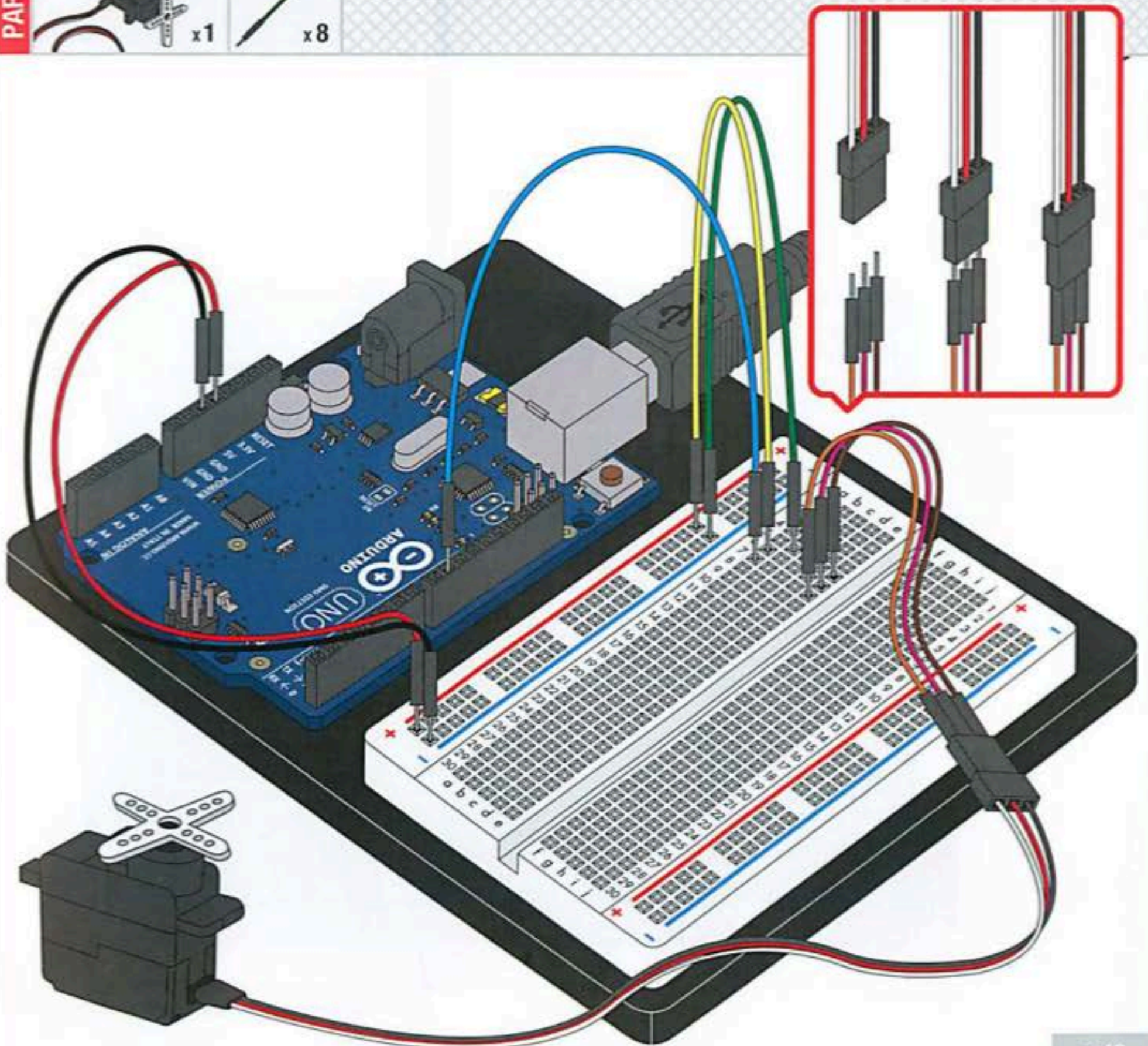


PARTS:

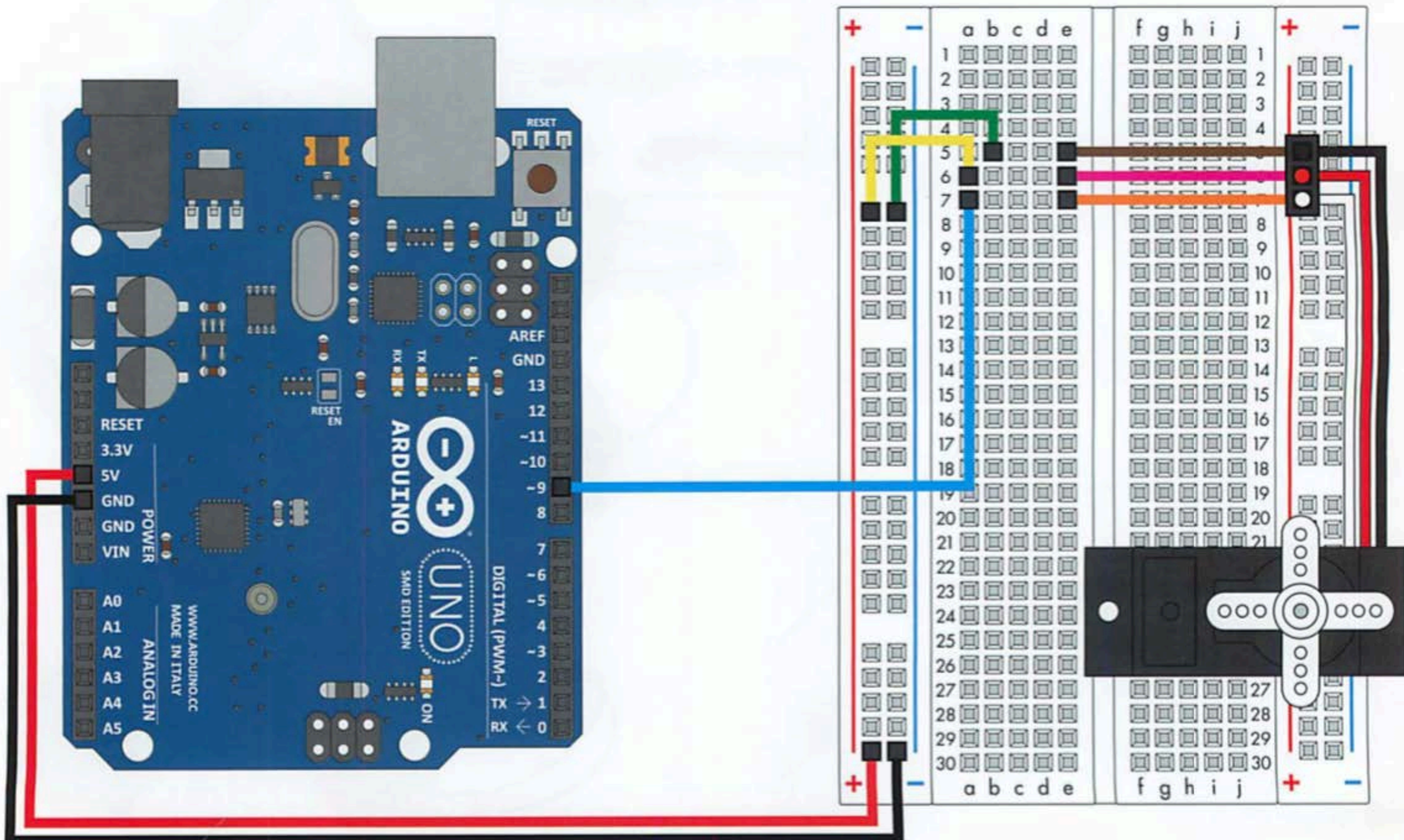
Servo



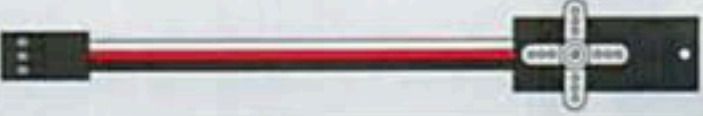








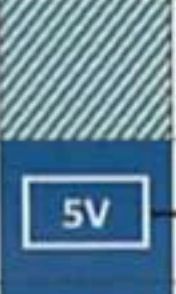







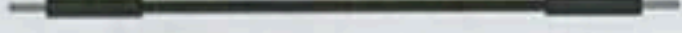


Wire



Circuit 8: A Single Servo



Component:	Image Reference:		
Servo			e5 e6 e7
Jumper Wire			e5 
Jumper Wire			e6 
Jumper Wire			e7 
Jumper Wire		Pin 9	a7
Jumper Wire			b5 -
Jumper Wire			a6 +
Jumper Wire		5V	+
Jumper Wire		GND	-

Expand your horizons using Libraries:

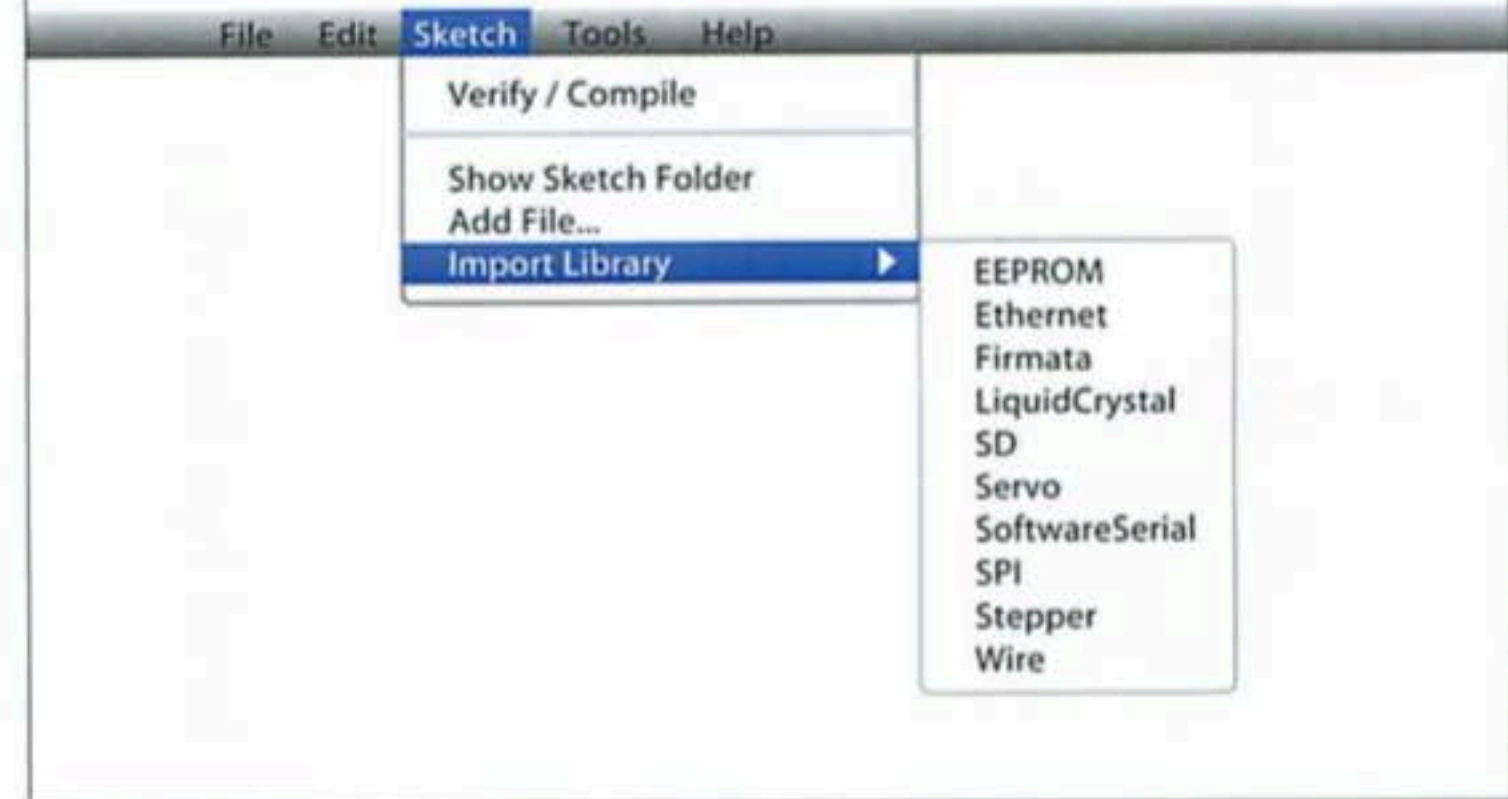
Arduino gives you a very useful set of built-in commands for doing basic input and output, making decisions using logic, solving math problems, etc. But the real power of Arduino is the huge community using it, and their willingness to share their work.

Libraries are collections of new commands that have been packaged together to make it easy to include them in your sketches. Arduino comes with a handful of useful libraries, such as the servo library used in this example, that can be used to interface to more advanced devices (LCD displays, stepper motors, ethernet ports, etc.)

See <http://arduino.cc/en/Reference/Libraries> for a list of the standard libraries and information on using them.

But anyone can create a library, and if you want to use a new sensor or output device, chances are that someone out there has already written one that interfaces that device to the Arduino. Many of Vilros's products come with Arduino libraries, and you can find even more using Google and the Arduino Playground at <http://arduino.cc/playground/>. And when YOU get the Arduino working with a new device, consider making a library for it and sharing it with the world!

To use a library in a sketch, select it from **Sketch > Import Library**.





Open Arduino IDE // File > Examples > USK Guide > Circuit # 8

Code to Note:



`#include <Servo.h>`



`#include` is a special "preprocessor" command that inserts a library (or any other file) into your sketch. You can type this command yourself, or choose an installed library from the "sketch / import library" menu.

`Servo servo1;`

`servo1.attach(9);`



The servo library adds new commands that let you control a servo. To prepare the Arduino to control a servo, you must first create a Servo "object" for each servo (here we've named it "servo1"), and then "attach" it to a digital pin (here we're using pin 9).

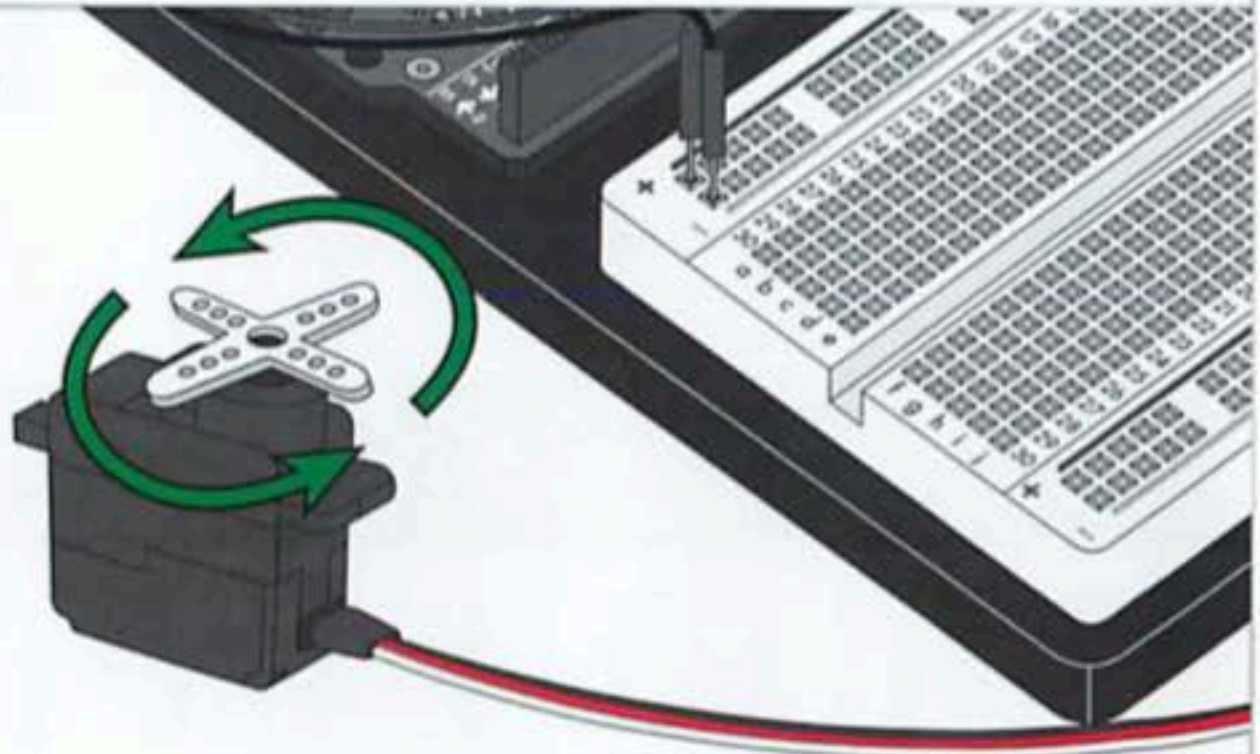
`servo1.write(180);`



Servos don't spin all the way around, but they can be commanded to move to a specific position. We use the servo library's `write()` command to move a servo to a specified number of degrees (0 to 180). Remember that the servo requires time to move, so give it a short `delay()` if necessary.

What You Should See:

You should see your servo motor move to various locations at several speeds. If the motor doesn't move, check your connections and make sure you have verified and uploaded the code, or see the troubleshooting tips below.



Troubleshooting:

Servo Not Twisting

Even with colored wires it is still shockingly easy to plug a servo in backward. This might be the case.

Still Not Working

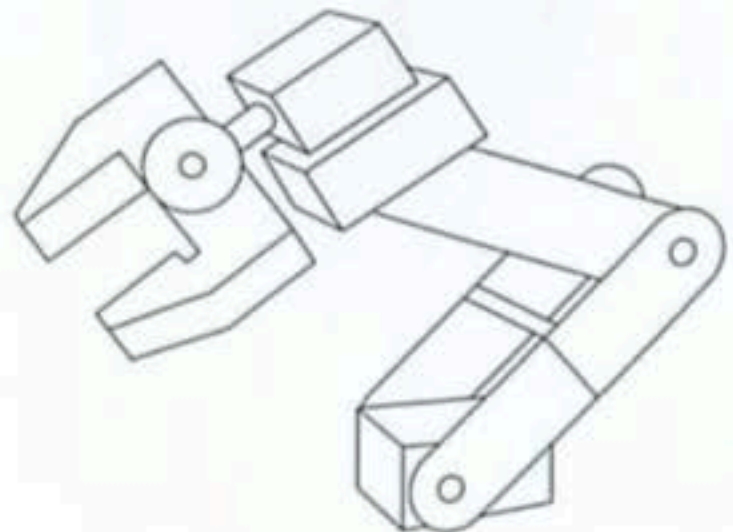
A mistake we made a time or two was simply forgetting to connect the power (red and brown wires) to +5 volts and ground.

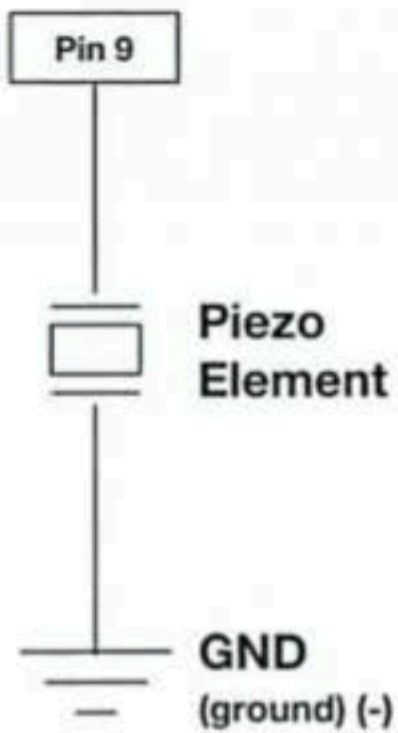
Fits and Starts

If the servo begins moving then twitches, and there's a flashing light on your Arduino board, the power supply you are using is not quite up to the challenge. Using a wall adapter instead of USB should solve this problem.

Real World Application:

Robotic arms you might see in an assembly line or sci-fi movie probably have servos in them.





Buzzer

In this circuit, we'll again bridge the gap between the digital world and the analog world. We'll be using a buzzer that makes a small "click" when you apply voltage to it (try it!). By itself that isn't terribly exciting, but if you turn the voltage on and off hundreds of times a second, the buzzer will produce a tone. And if you string a bunch of tones together, you've got music! This circuit and sketch will play a classic tune. We'll never let you down!

PARTS:

Piezo Element



x1

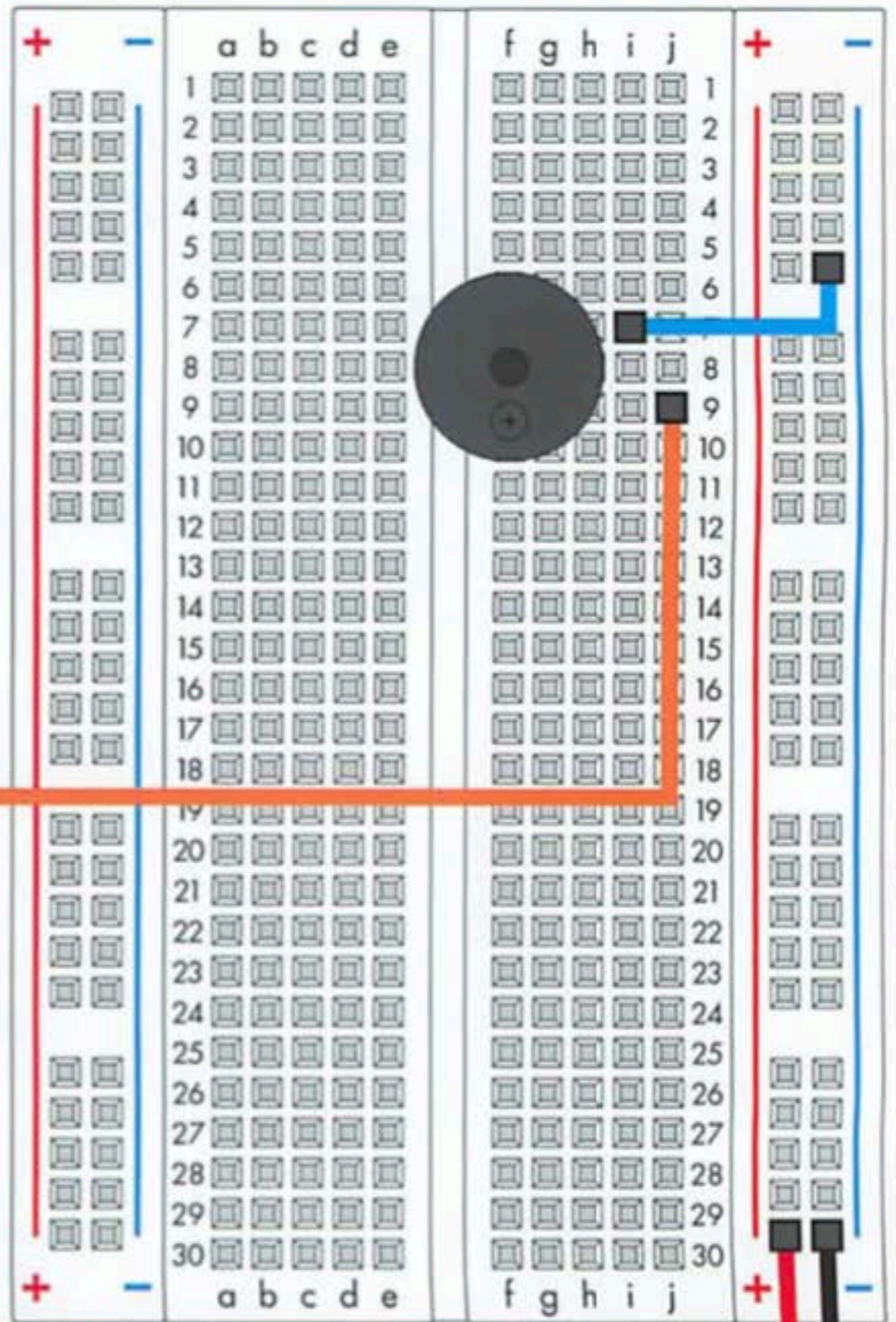
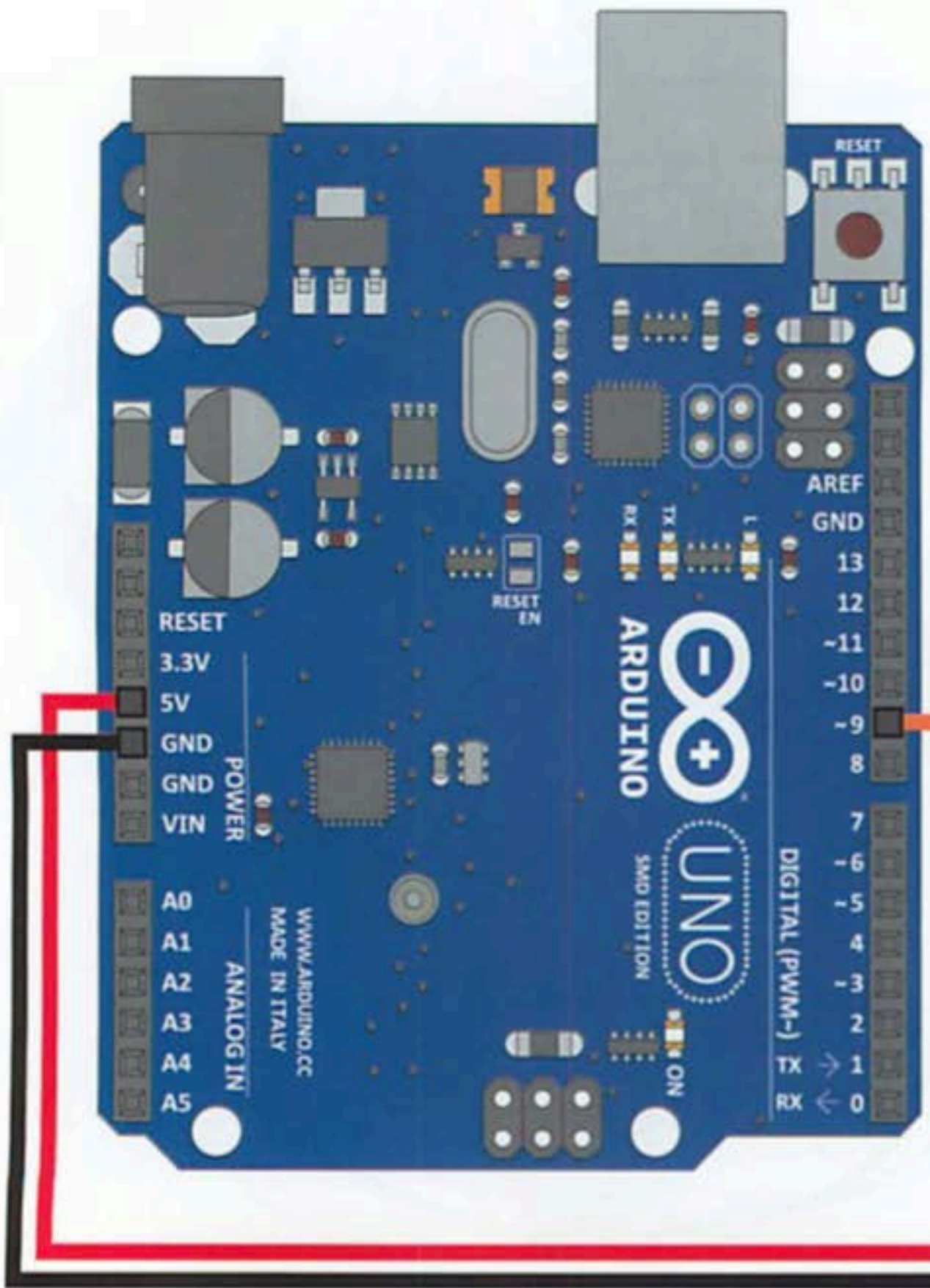
Wire












x4



+ If the buzzer doesn't easily fit into the holes on the breadboard, try rotating it slightly.



Component:	Image Reference:		
Piezo Element			<input type="text" value="i9"/> + <input type="text" value="i7"/>
Jumper Wire			<input type="text" value="i7"/> -
Jumper Wire		<input type="text" value="Pin 9"/>	<input type="text" value="i9"/>
Jumper Wire		<input type="text" value="5V"/>	<input data-bbox="1458 600 1520 660" type="text" value="+"/>
Jumper Wire		<input type="text" value="GND"/>	<input data-bbox="1458 743 1520 803" type="text" value="-"/>

Creating your own functions:

Arduino contains a wealth of built-in functions that are useful for all kinds of things. (See <http://arduino.cc/en/Reference> for a list). But you can also easily create your own functions. Here's a simple example named "add", which adds two numbers together and returns the result. Let's break it down.

```
int add(int parameter1, int parameter2)
{
    int x;

    x = parameter1 + parameter2;

    return(x);
}
```

Your functions can take in values ("parameters"), and return a value, as this one does. But you can also do either or none of those things, if you wish.

If you'll be passing parameters *to* your function, put them (and their types) in the parentheses after the function name. If you won't be giving your function any parameters, just use an empty parenthesis () after the name.

If you'll be returning a value *from* your function, put the type of the return value in front of the function name. Then in your function, when you're ready to return the value, put in a `return()` statement. If you won't be returning a value, put "void" in front of the function name (just like you've already seen for the `setup()` and `loop()` functions).

When you write your own functions, you make your code neater and easier to re-use.



Open Arduino IDE // File > Examples > USK Guide > Circuit # 9

Code to Note:



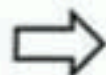
```
char notes[] = "cdfda ag cdfdg gf";
```

```
char names[] = {'c','d','e','f','g','a','b','C'};
```



Up until now we've been working solely with numerical data, but the Arduino can also work with text. Characters (single, printable, letters, numbers and other symbols) have their own type, called "char". When you have an array of characters, it can be defined between double-quotes (also called a "string"), OR as a list of single-quoted characters.

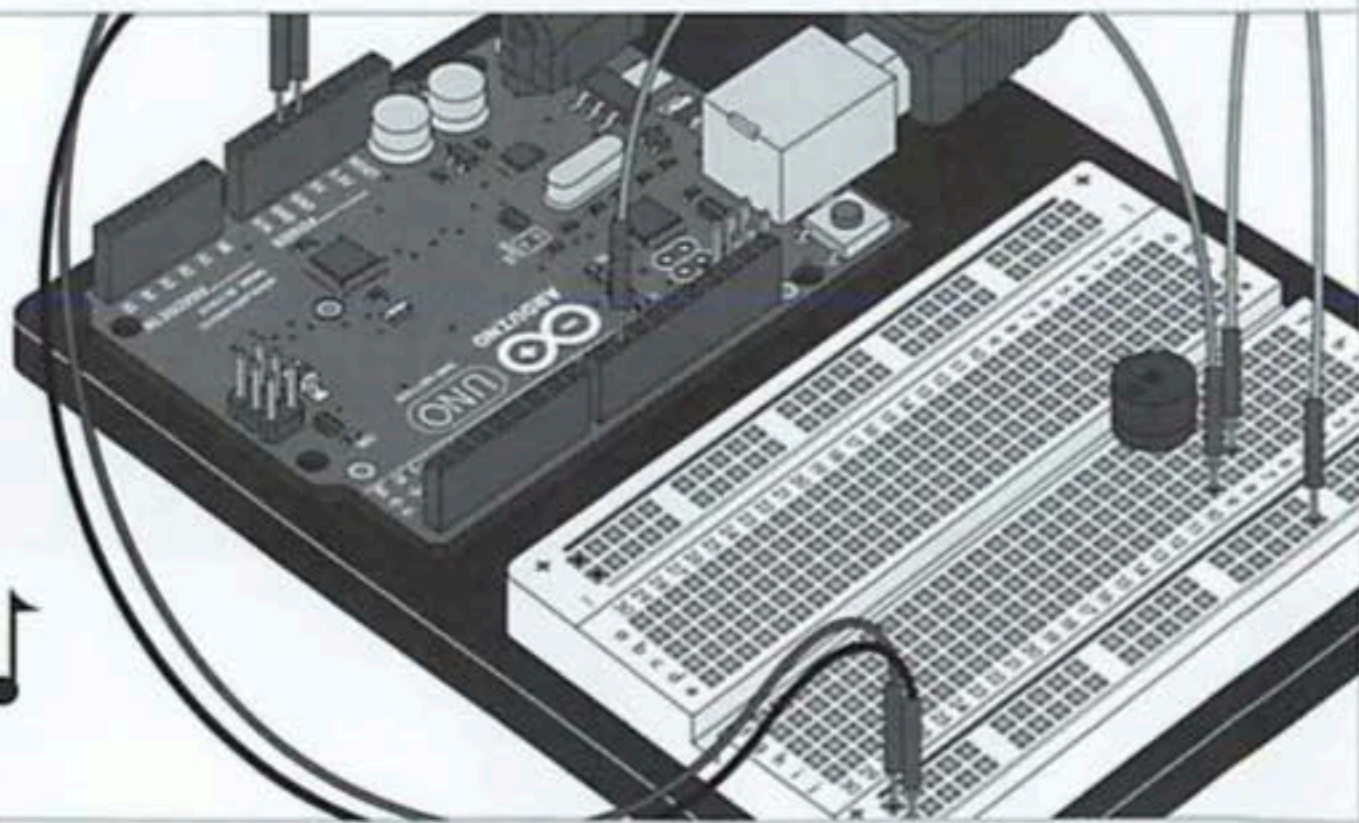
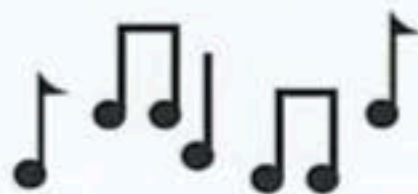
```
tone(pin, frequency, duration);
```



One of Arduino's many useful built-in commands is the `tone()` function. This function drives an output pin at a certain frequency, making it perfect for driving buzzers and speakers. If you give it a duration (in milliseconds), it will play the tone then stop. If you don't give it a duration, it will keep playing the tone forever (but you can stop it with another function, `noTone()`).

What You Should See:

You should see - well, nothing! But you should be able to hear you piezo element playing "Twinkle, Twinkle Little Star" (or possibly, "The ABCs"). If it isn't working, make sure you have assembled the circuit correctly and verified and uploaded the code to your board or see the troubleshooting tips below.



Troubleshooting:

No Sound

Given the size and shape of the piezo element it is easy to miss the right holes on the breadboard. Try double checking its placement.

Can't Think While the Melody is Playing

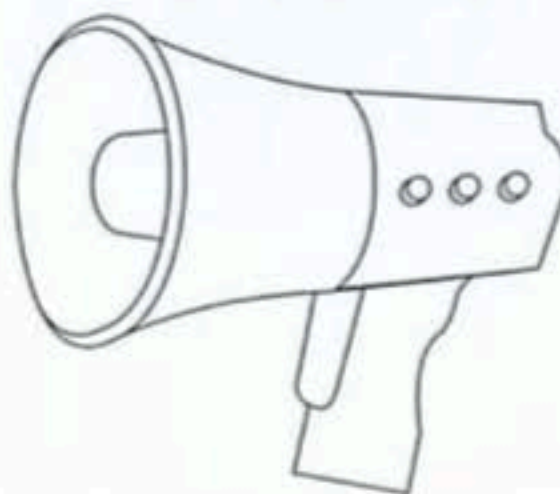
Just pull up the piezo element whilst you think, upload your program then plug it back in.

Tired of Twinkle Twinkle Little Star

The code is written so you can easily add your own songs.


Real World Application:

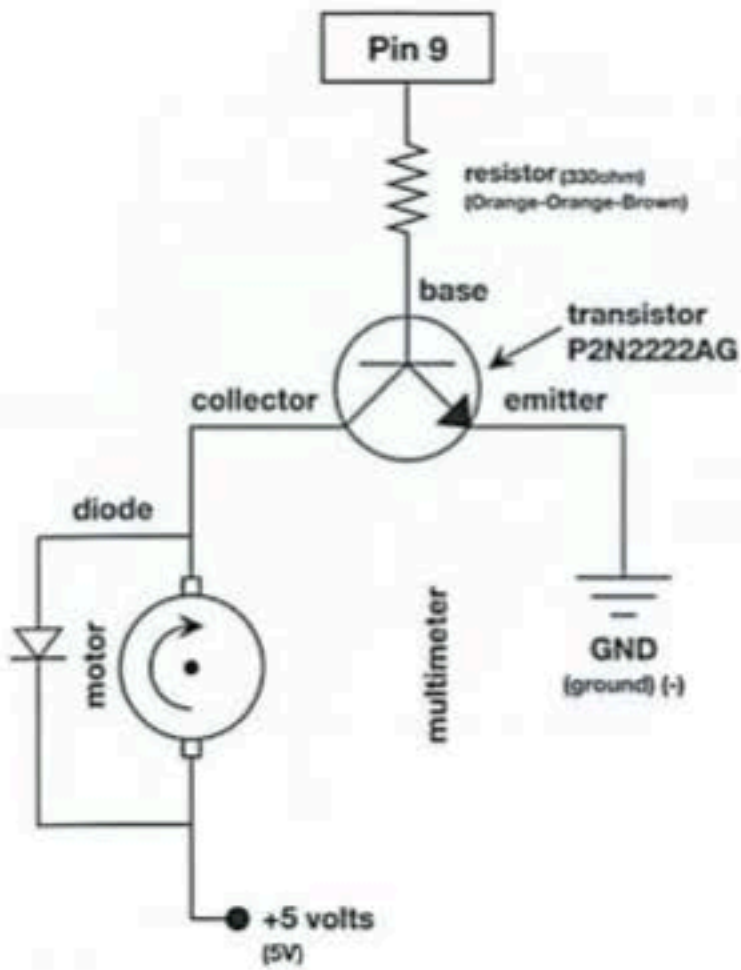
Many modern megaphones have settings that use a loud amplified buzzer. They are usually very loud and quite good at getting people's attention.



Spinning a Motor

Remember before when you played around with a servo motor? Now we are going to tackle spinning a motor. This requires the use of a transistor, which can switch a larger amount of current than the Arduino can. When using a transistor, you just need to make sure its maximum specs are high enough for your use. The transistor we are using for this circuit is rated at 40V max and 200 milliamps max – perfect for our toy motor!

 When you're building the circuit be careful not to mix up the transistor and the temperature sensor, they're almost identical.



PARTS:

Transistor
P2N2222AG



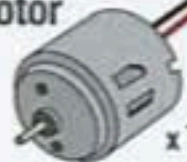
x1

Diode
1N4148



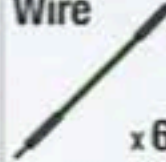
x1

DC Motor



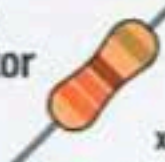
x1

Wire

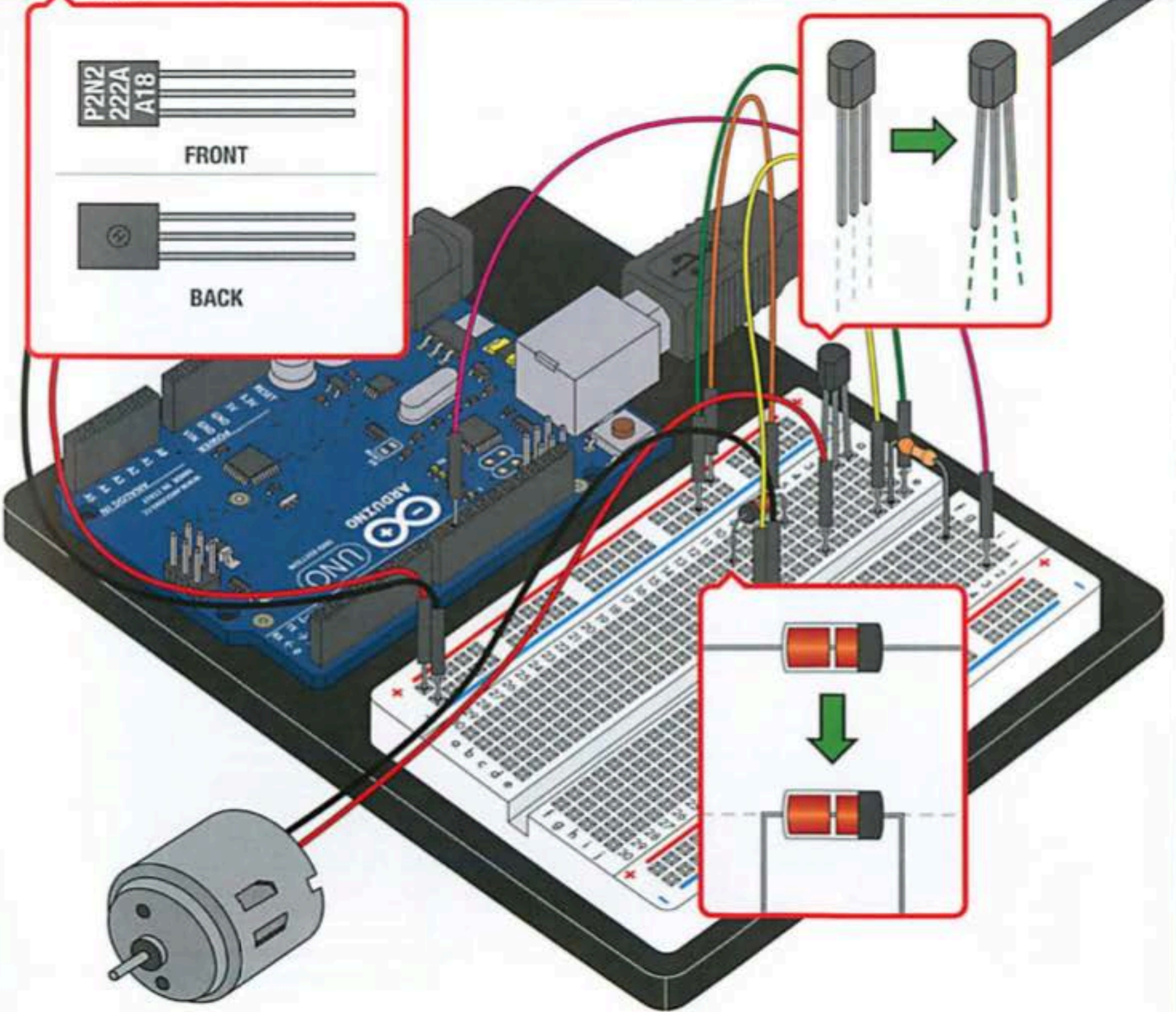
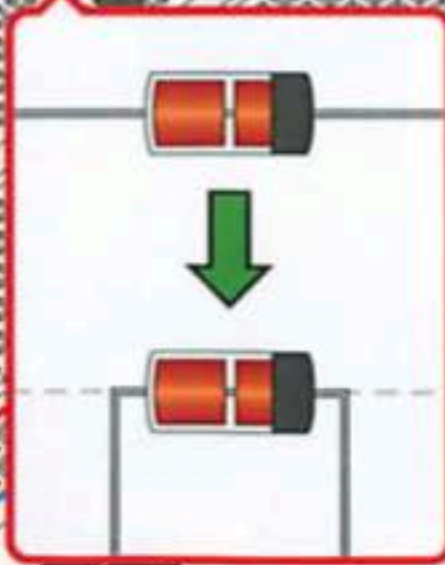
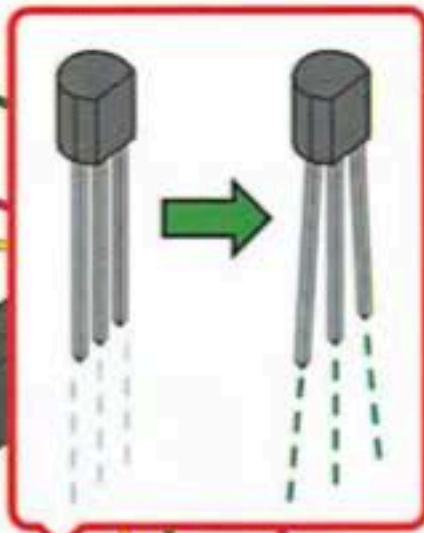
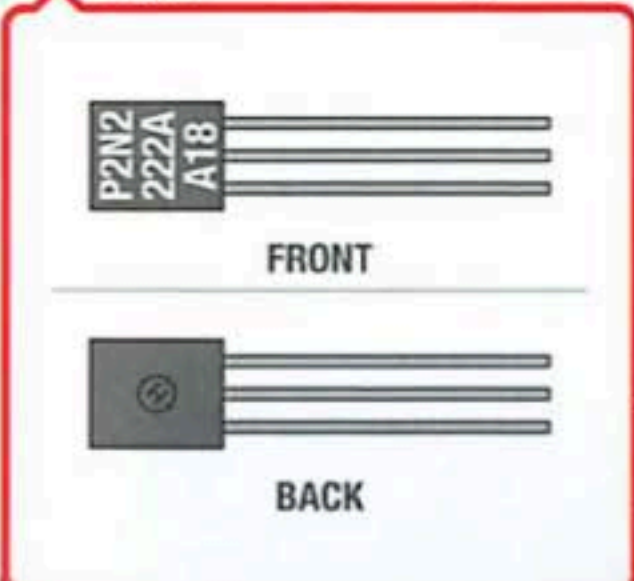


x6

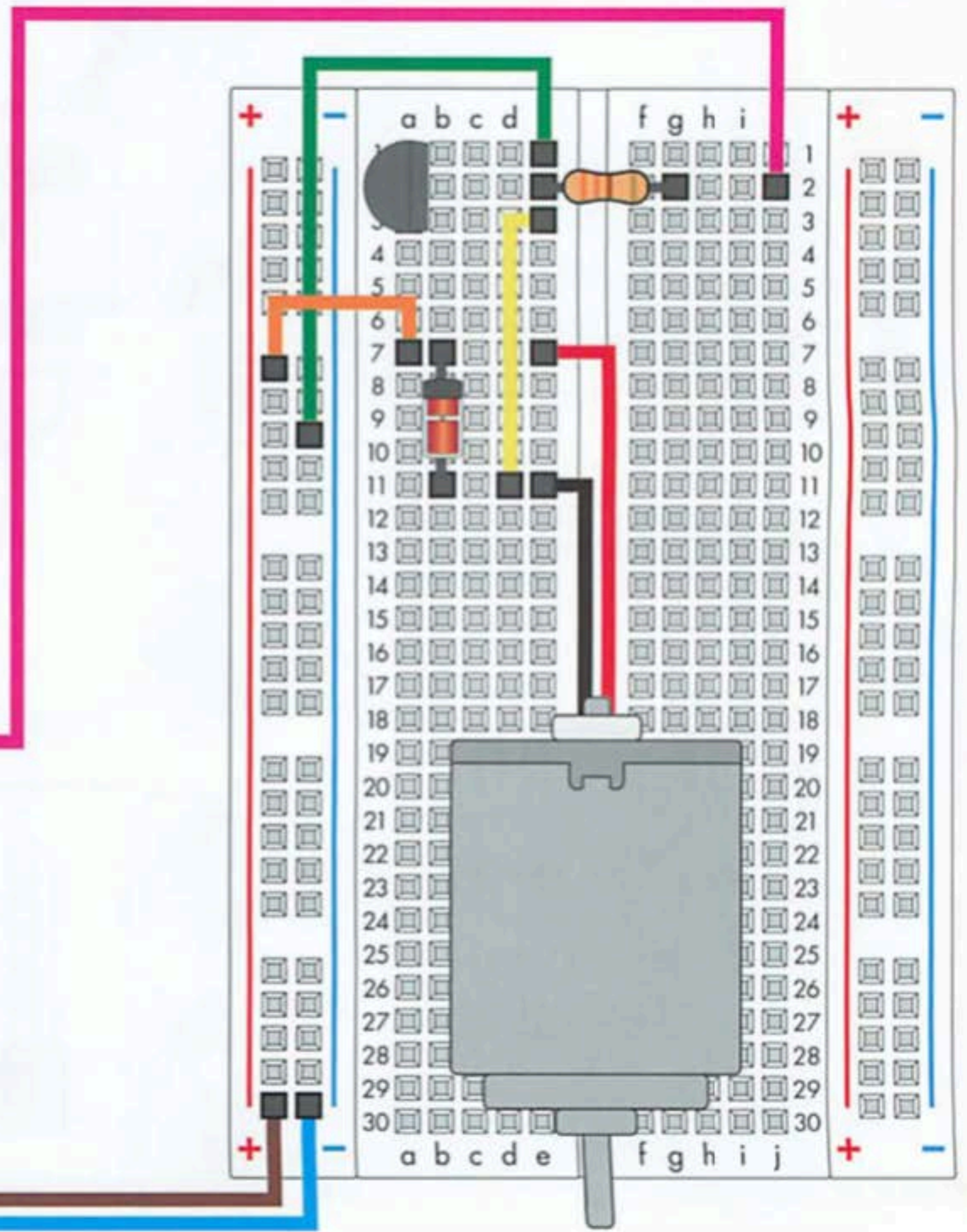
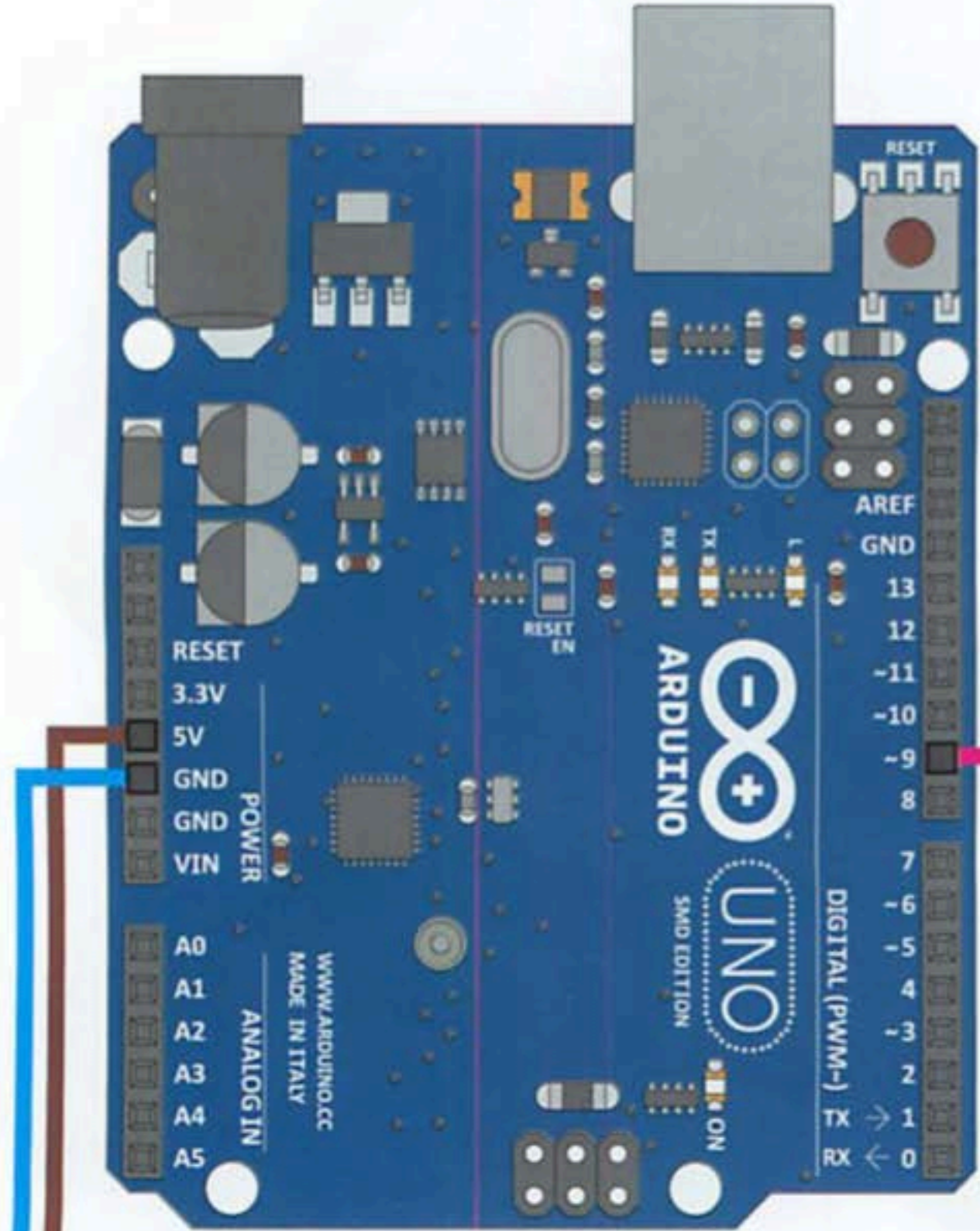
330Ω
Resistor





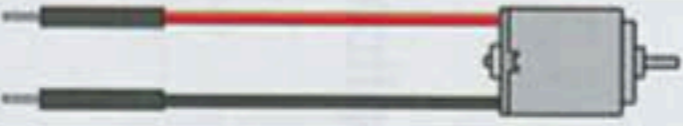









x1



Circuit 10 : Spinning a Motor



Component:	Image Reference:		
Transistor P2N2222AG			
Diode 1N4148			a1 a2 a3
DC Motor			b7 b11
330Ω Resistor			e7 e11
Jumper Wire			e2 g2
Jumper Wire		Pin 9	e1 -
Jumper Wire			j2
Jumper Wire			a7 +
Jumper Wire		5V	e3 d11
Jumper Wire		GND	+ -

Putting it all together:

At this point you're probably starting to get your own ideas for circuits that do fun things, or help solve a real problem. Excellent! Here are some tips on programming in general.

Most of the sketches you write will be a loop with some or all of these steps:

1. Perform some sort of input
2. Make some calculations or decisions
3. Perform some sort of output
4. Repeat! (Or not!)

We've already shown you how to use a bunch of different input sensors and output devices (and we still have a few more to go). Feel free to make use of the examples in your own sketches - this is the whole idea behind the "Open Source" movement.

It's usually pretty easy to pull pieces of different sketches together, just open them in two windows, and copy and paste between them. This is one of the reasons we've been promoting "good programming habits". Things like using constants for pin numbers, and breaking your sketch into functions, make it much easier to re-use your code in new sketches. For example, if you pull in two pieces of code that use the same pin, you can easily change one of the constants to a new pin. (Don't forget that not all of the pins support `analogWrite()`; the compatible pins are marked on your board.)

If you need help, there are internet forums where you can ask questions. Try Arduino's forum at arduino.cc/forum, and Vilros's at forum.vilros.com. When you're ready to move to more advanced topics, take a look at Arduino's tutorials page at arduino.cc/en/Tutorial. Many of Vilros's more advanced products were programmed with Arduino, (allowing you to easily modify them), or have Arduino examples for them. See our product pages for info.

Finally, when you create something really cool, consider sharing it with the world so that others can learn from your genius. (And be sure to let us know so we can put it on our home page!)

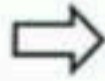


Open Arduino IDE // File > Examples > USK Guide > Circuit # 10

Code to Note:



`while (Serial.available() > 0)`



The Arduino's serial port can be used to receive as well as send data. Because data could arrive at any time, the Arduino stores, or "buffers" data coming into the port until you're ready to use it. The `Serial.available()` command returns the number of characters that the port has received, but haven't been used by your sketch yet. Zero means no data has arrived.

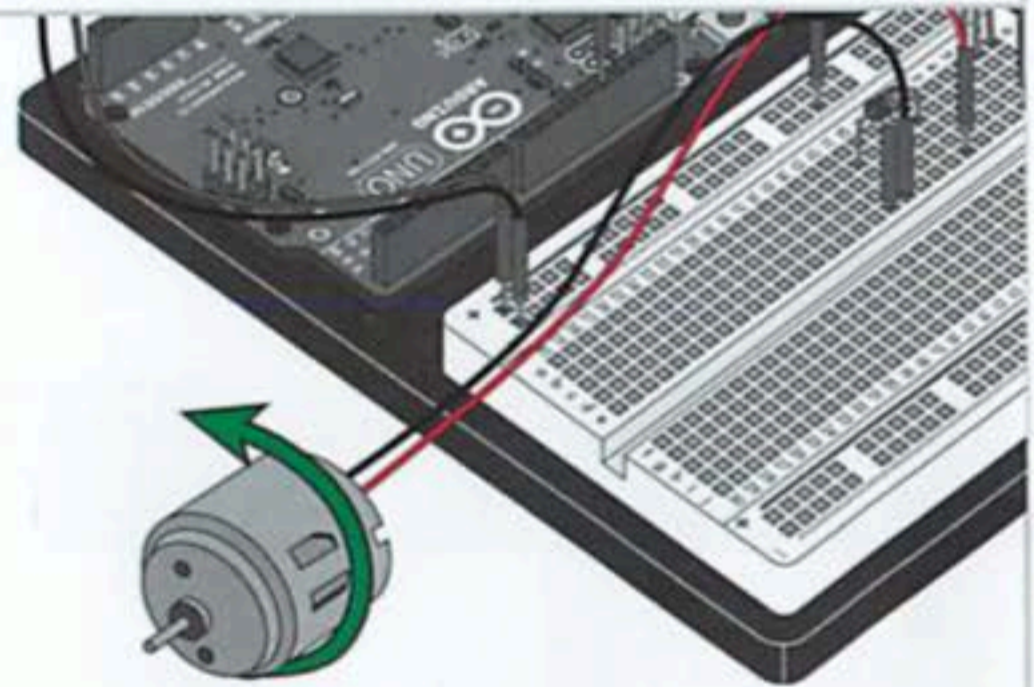
`speed = Serial.parseInt();`



If the port has data waiting for you, there are a number of ways for you to use it. Since we're typing numbers into the port, we can use the handy `Serial.parseInt()` command to extract, or "parse" integer numbers from the characters it's received. If you type "1" "0" "0" to the port, this function will return the number 100.

What You Should See:

The DC Motor should spin if you have assembled the circuit's components correctly, and also verified/uploaded the correct code. If your circuit is not working check the troubleshooting section below.



Troubleshooting:

Motor Not Spinning

If you sourced your own transistor, double check with the data sheet that the pinout is compatible with a P2N2222AG (many are reversed).

Still No Luck

If you sourced your own motor, double check that it will work with 5 volts and that it does not draw too much power.

Still Not Working

Sometimes the Arduino board will disconnect from the computer. Try un-plugging and then re-plugging it into your USB port.

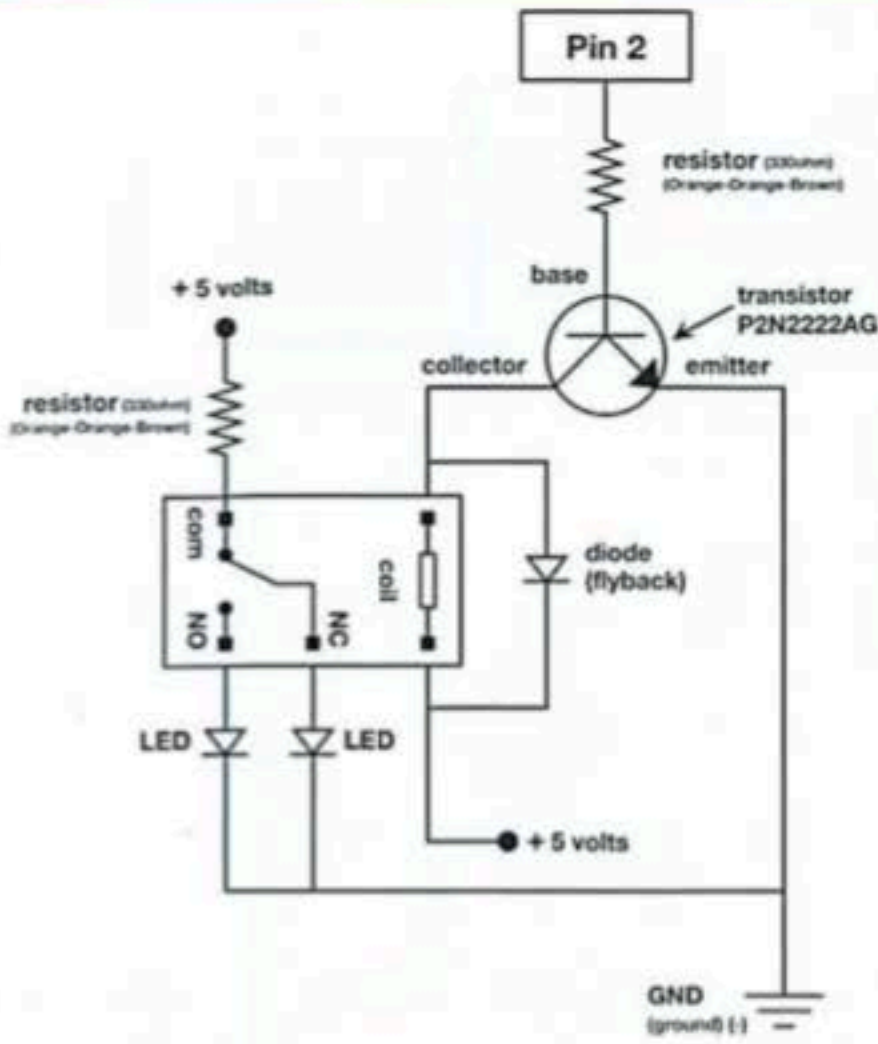
Real World Application:


Radio Controlled(RC) cars use Direct Current(DC) motors to turn the wheels for propulsion.



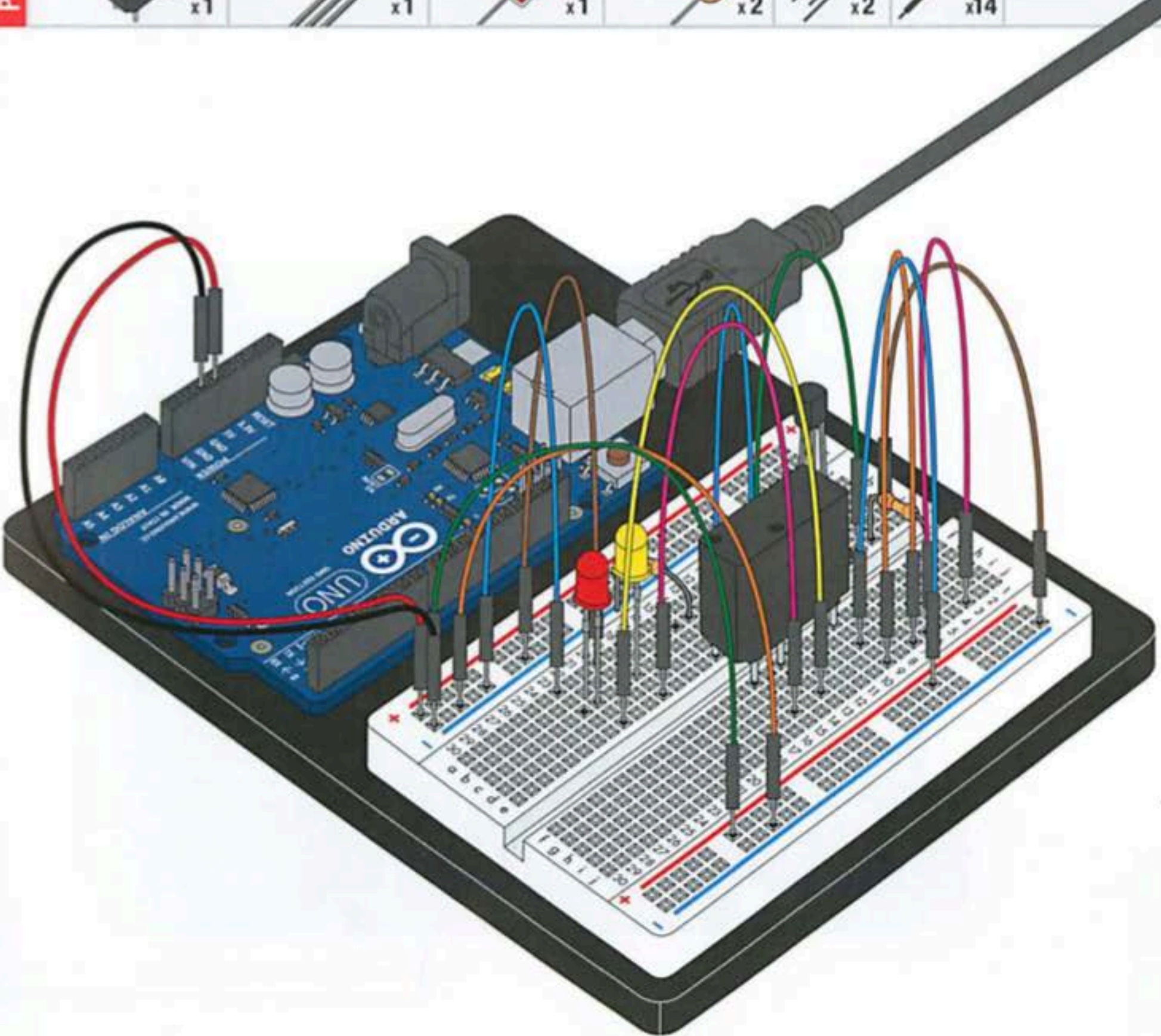
Relays

In this circuit, we are going to use some of the lessons we learned in circuit 12 to control a relay. A relay is basically an electrically controlled mechanical switch. Inside that harmless looking plastic box is an electromagnet that, when it gets a jolt of energy, causes a switch to trip. In this circuit, you'll learn how to control a relay like a pro – giving your Arduino even more powerful abilities!

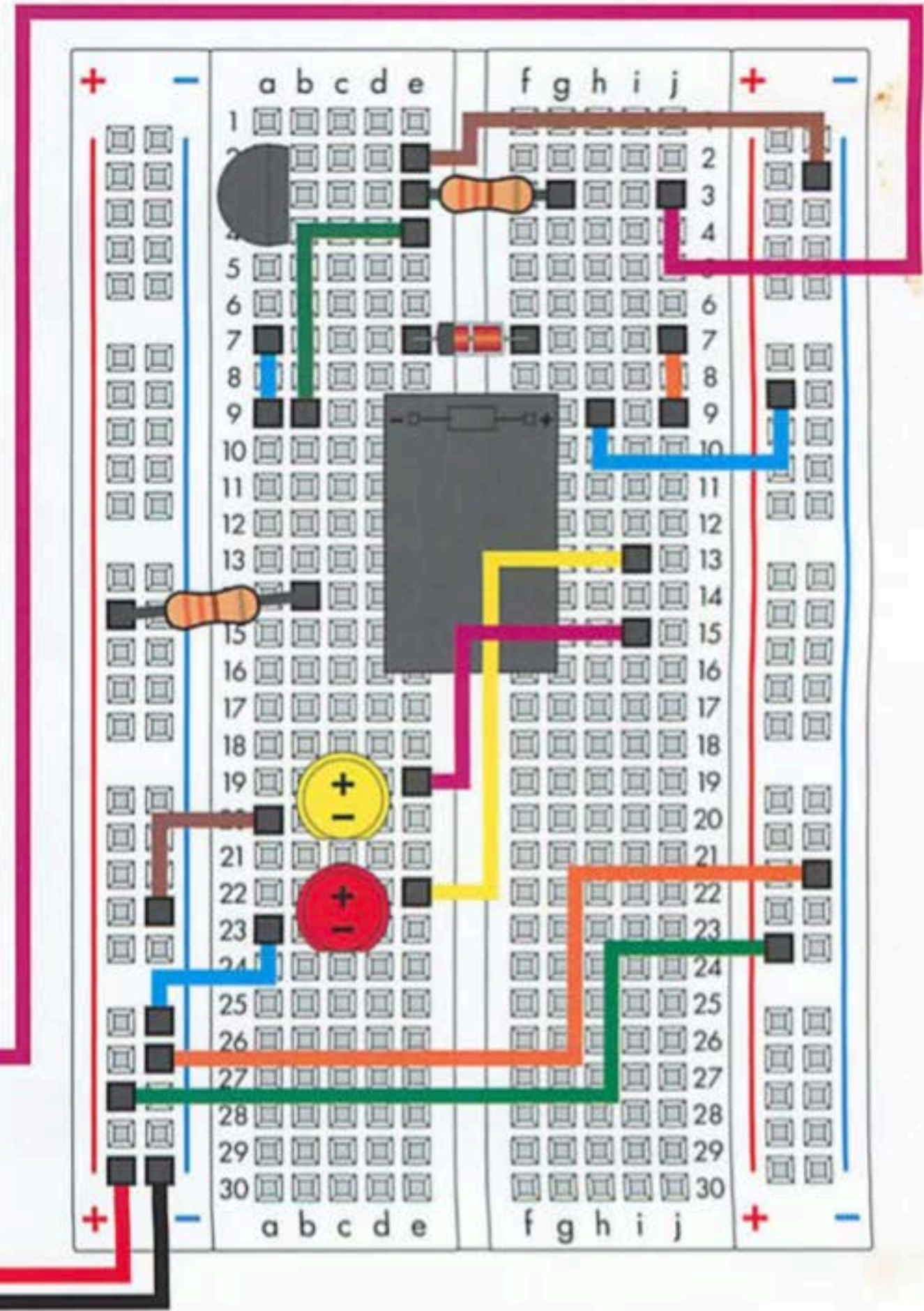
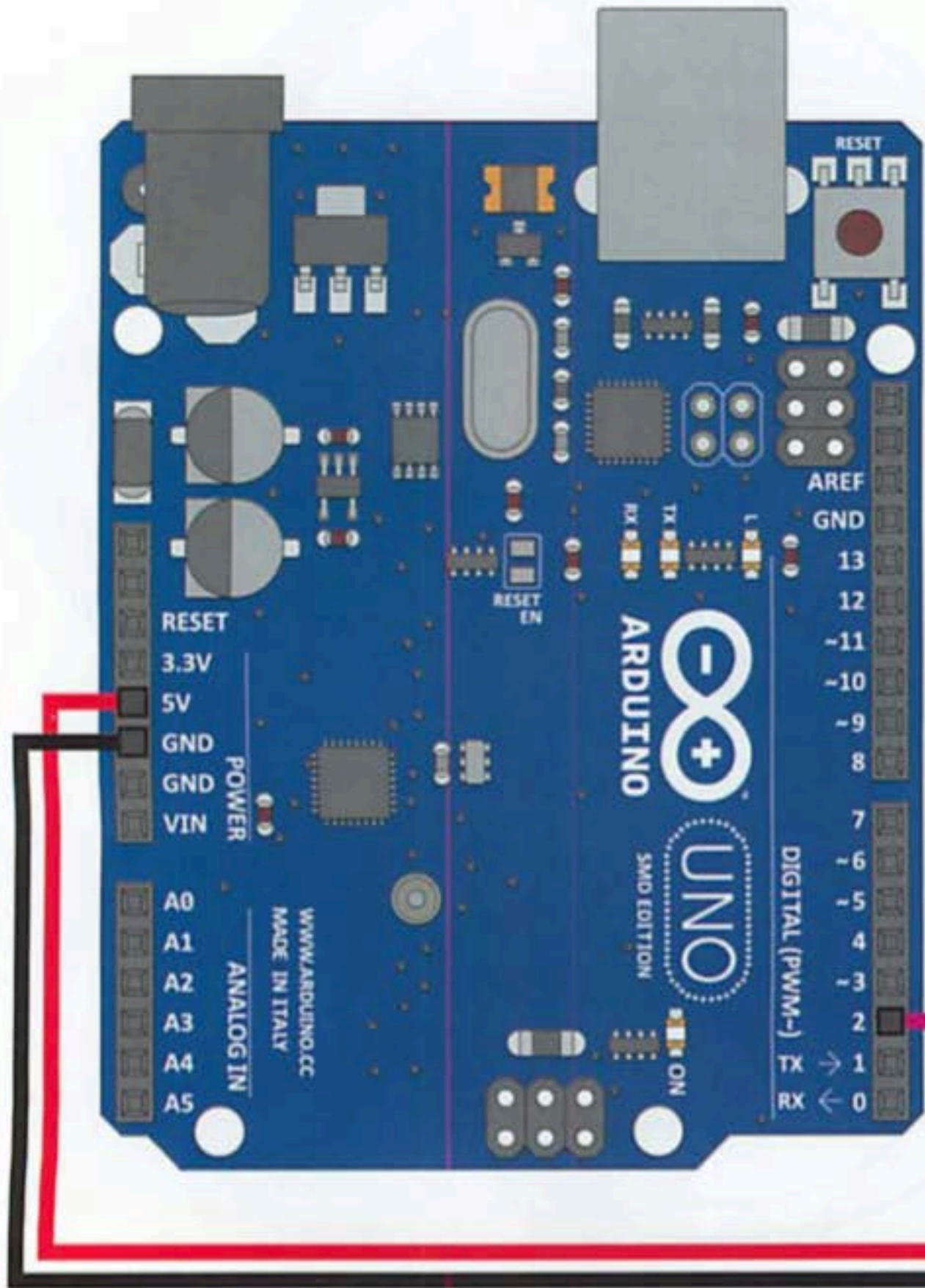







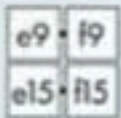

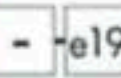

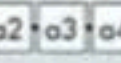




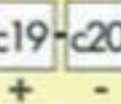

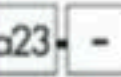


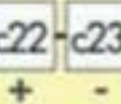

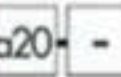

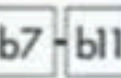



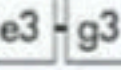



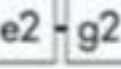




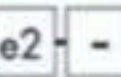




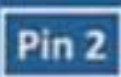


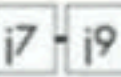

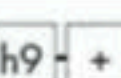

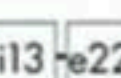

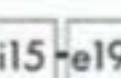
 When the relay is off, the COM (common) pin will be connected to the NC (Normally Closed) pin. When the relay is on, the COM (common) pin will be connected to the NO (Normally Open) pin.

- PARTS:**
- Relay x1
 - Transistor P2N2222AG x1
 - Diode 1N4148 x1
 - 330Ω Resistor x2
 - LED x2
 - Wire x14



Circuit 11: Relays



Component:	Image Reference:			Component:	Image Reference:		
Relay			 e9 - f9 e15 - f15	Jumper Wire			 - e19
Transistor P2N2222AG			 a2 - a3 - a4	Jumper Wire			 + -
LED (5mm) 	 + -		 c19 - c20 + -	Jumper Wire			 a23 - -
LED (5mm) 	 + -		 c22 - c23 + -	Jumper Wire			 a20 - -
Diode 1N4148			 b7 - b11	Jumper Wire			 a7 - a9
330Ω Resistor			 e3 - g3	Jumper Wire			 e4 - e9
330Ω Resistor			 e2 - g2	Jumper Wire		 5V	 +
Jumper Wire			 e2 - -	Jumper Wire		 GND	 -
Jumper Wire		 Pin 2	 j3				
Jumper Wire			 j7 - j9				
Jumper Wire			 h9 - +				
Jumper Wire			 i13 - e22				
Jumper Wire			 i15 - e19				



Open Arduino IDE // File > Examples > USK Guide > Circuit # 11

Code to Note:



`digitalWrite(relayPin, HIGH);`



When we turn on the transistor, which in turn energizes the relay's coil, the relay's switch contacts are closed. This connects the relay's COM pin to the NO (Normally Open) pin. Whatever you've connected using these pins will turn on. (Here we're using LEDs, but this could be almost anything.)

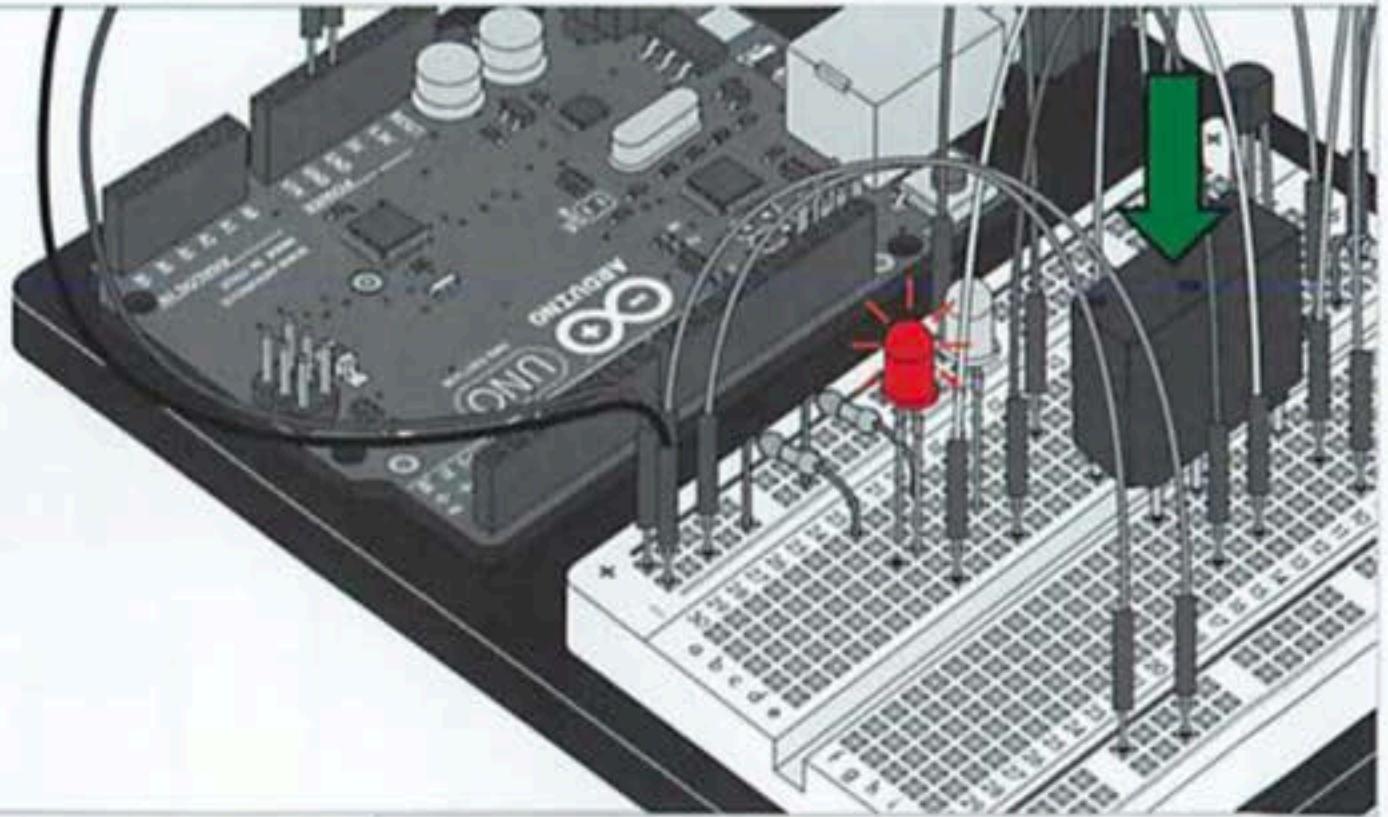
`digitalWrite(relayPin, LOW);`



The relay has an additional contact called NC (Normally Closed). The NC pin is connected to the COM pin when the relay is OFF. You can use either pin depending on whether something should be normally on or normally off. You can also use both pins to alternate power to two devices, much like railroad crossing warning lights.

What You Should See:

You should be able to hear the relay contacts click, and see the two LEDs alternate illuminating at 1-second intervals. If you don't, double-check that you have assembled the circuit correctly, and uploaded the correct sketch to the board. Also, see the troubleshooting tips below.



Troubleshooting:

LEDs Not Lighting

Double-check that you've plugged them in correctly. The longer lead (and non-flat edge of the plastic flange) is the positive lead.

No Clicking Sound

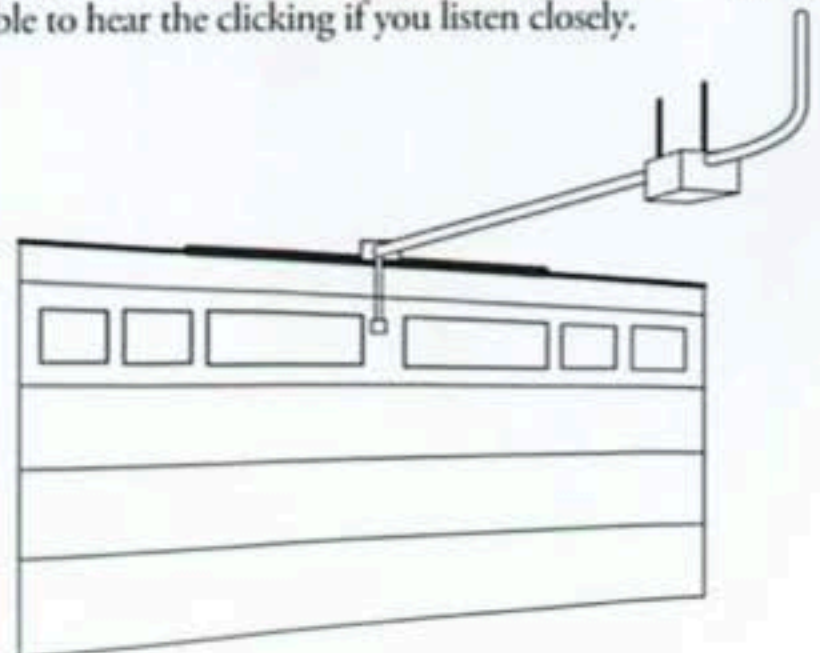
The transistor or coil portion of the circuit isn't quite working. Check the transistor is plugged in the right way.

Not Quite Working

The included relays are designed to be soldered rather than used in a breadboard. As such you may need to press it in to ensure it works (and it may pop out occasionally).

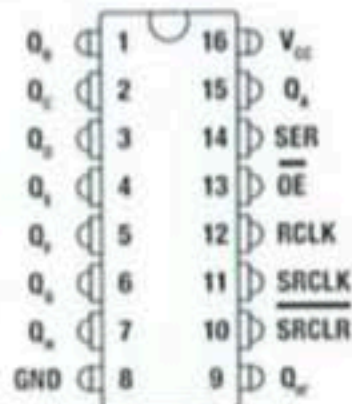
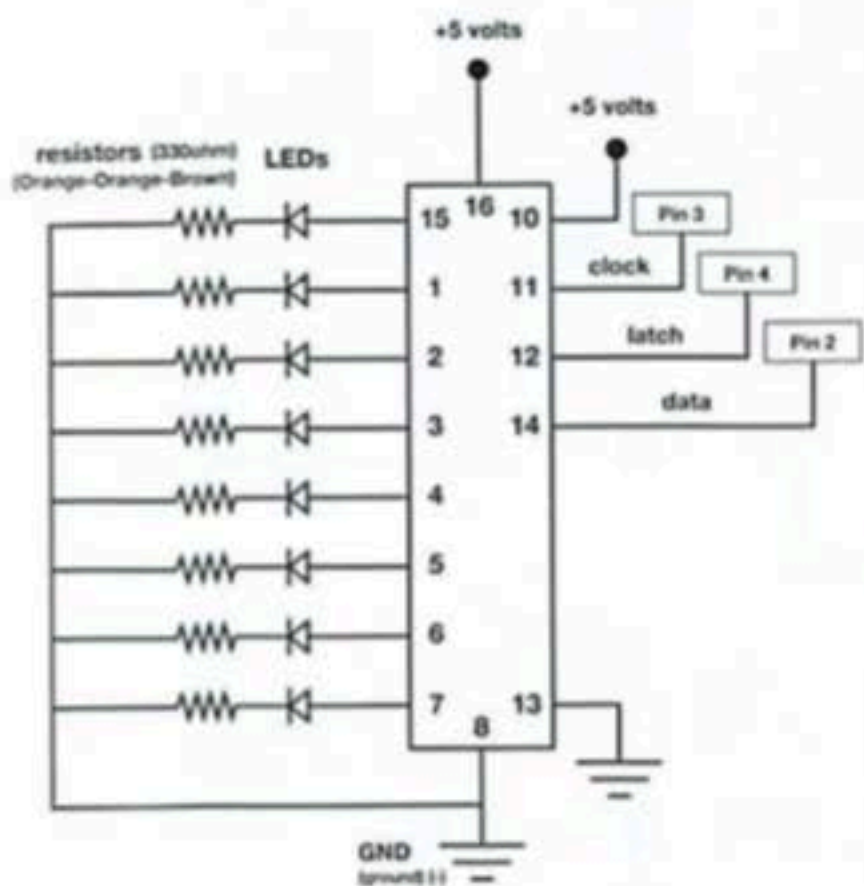
Real World Application:

Garage door openers use relays to operate. You might be able to hear the clicking if you listen closely.



Shift Register

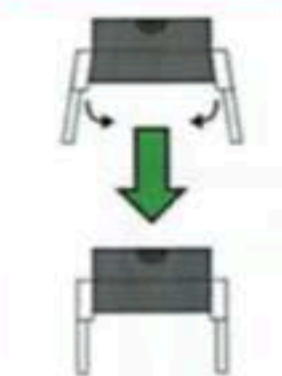
Now we are going to step into the world of ICs (integrated circuits). In this circuit, you'll learn all about using a shift register (also called a serial-to-parallel controller). The shift register will give your Arduino an additional eight outputs, using only three pins on your board. For this circuit, you'll practice by using the shift register to control eight LEDs.



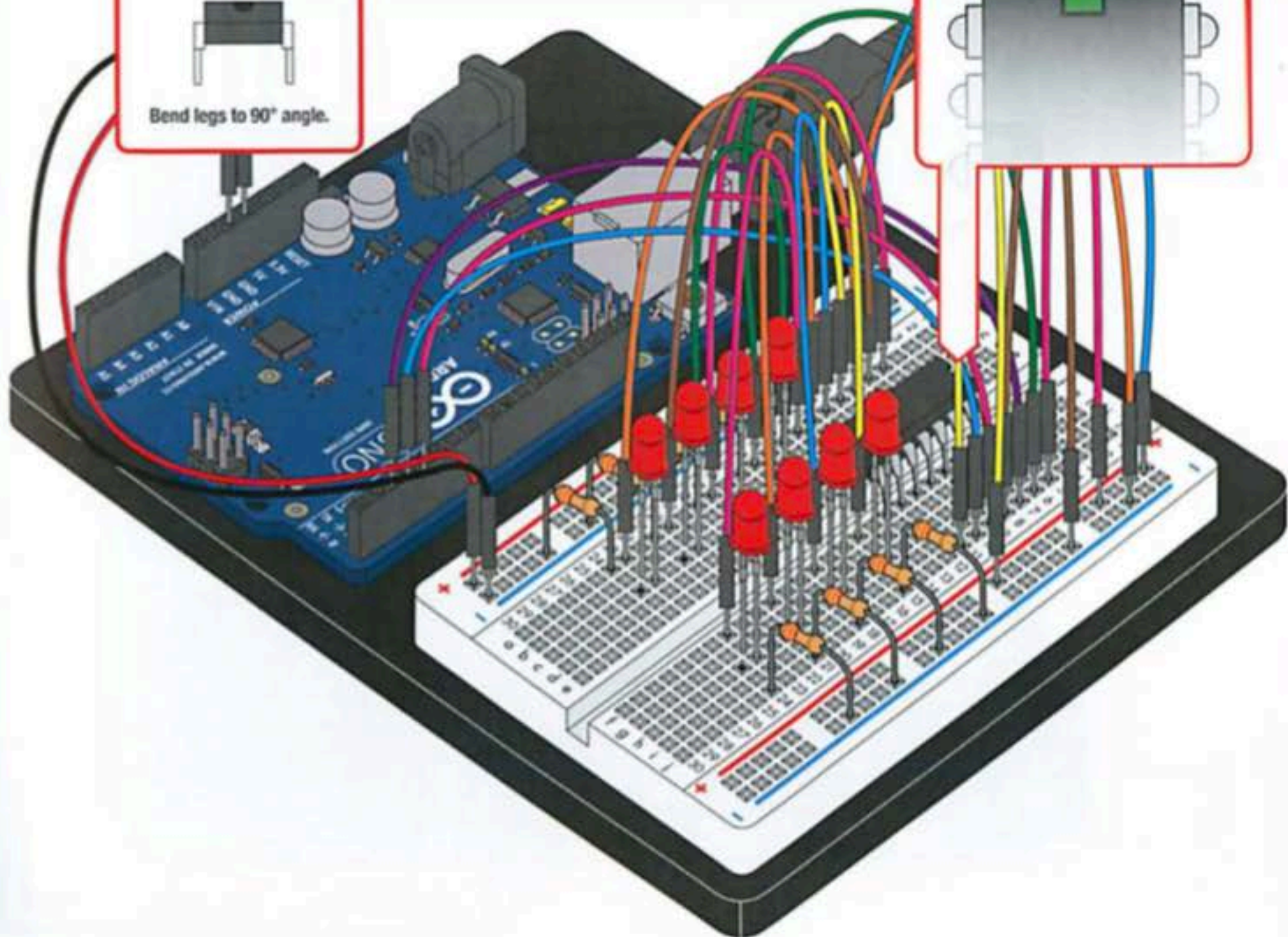
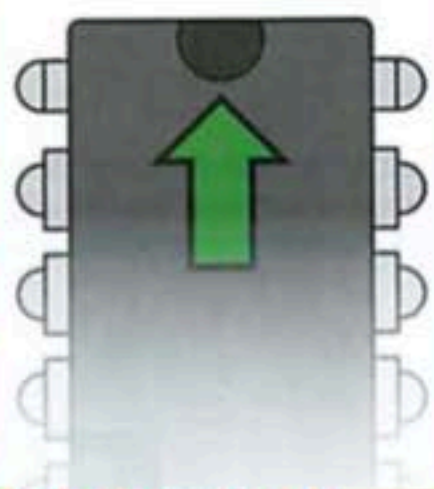
PARTS:


































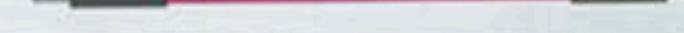



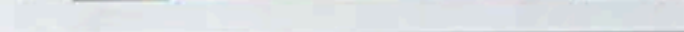


- IC x1
- LED x8
- 330Ω Resistor x8
- Wire x19

Align notch on top, inbetween "e5" and "f5" on the breadboard.



Bend legs to 90° angle.



Component:	Image Reference:			Component:	Image Reference:		
IC		e5 e6 e7 e8 i5 i6 i7 i8	e9 e10 e11 e12 i9 i10 i11 i12	Jumper Wire		-	-
LED (5mm)			c14 c15 +	Jumper Wire		i5	+
LED (5mm)			c17 c18 +	Jumper Wire		i6	a14
LED (5mm)			c20 c21 +	Jumper Wire		Pin 2	i7
LED (5mm)			c23 c24 +	Jumper Wire		i8	-
LED (5mm)			h14 h15 +	Jumper Wire		Pin 4	i9
LED (5mm)			h17 h18 +	Jumper Wire		Pin 3	i10
LED (5mm)			h20 h21 +	Jumper Wire		i11	+
LED (5mm)			h23 h24 +	Jumper Wire		f14	a8
330Ω Resistor			- a15	Jumper Wire		f17	a9
330Ω Resistor			- a18	Jumper Wire		f20	a10
330Ω Resistor			- a21	Jumper Wire		f23	a11
330Ω Resistor			- a24	Jumper Wire		a23	a7
330Ω Resistor			i15 -	Jumper Wire		a20	a6
330Ω Resistor			i18 -	Jumper Wire		a17	a5
330Ω Resistor			i21 -	Jumper Wire		a14	i6
330Ω Resistor			i24 -	Jumper Wire		5V	+
Jumper Wire			+ +	Jumper Wire		GND	-



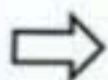
Open Arduino IDE // File > Examples > USK Guide > Circuit # 12

Code to Note:



You'll communicate with the shift register (and a lot of other parts) using an interface called SPI, or Serial Peripheral Interface. This interface uses a data line and a separate clock line that work together to move data in or out of the Arduino at high speed. The MSBFIRST parameter specifies the order in which to send the individual bits, in this case we're sending the Most Significant Bit first.

```
shiftOut(datapin, clockpin, MSBFIRST, data);
```

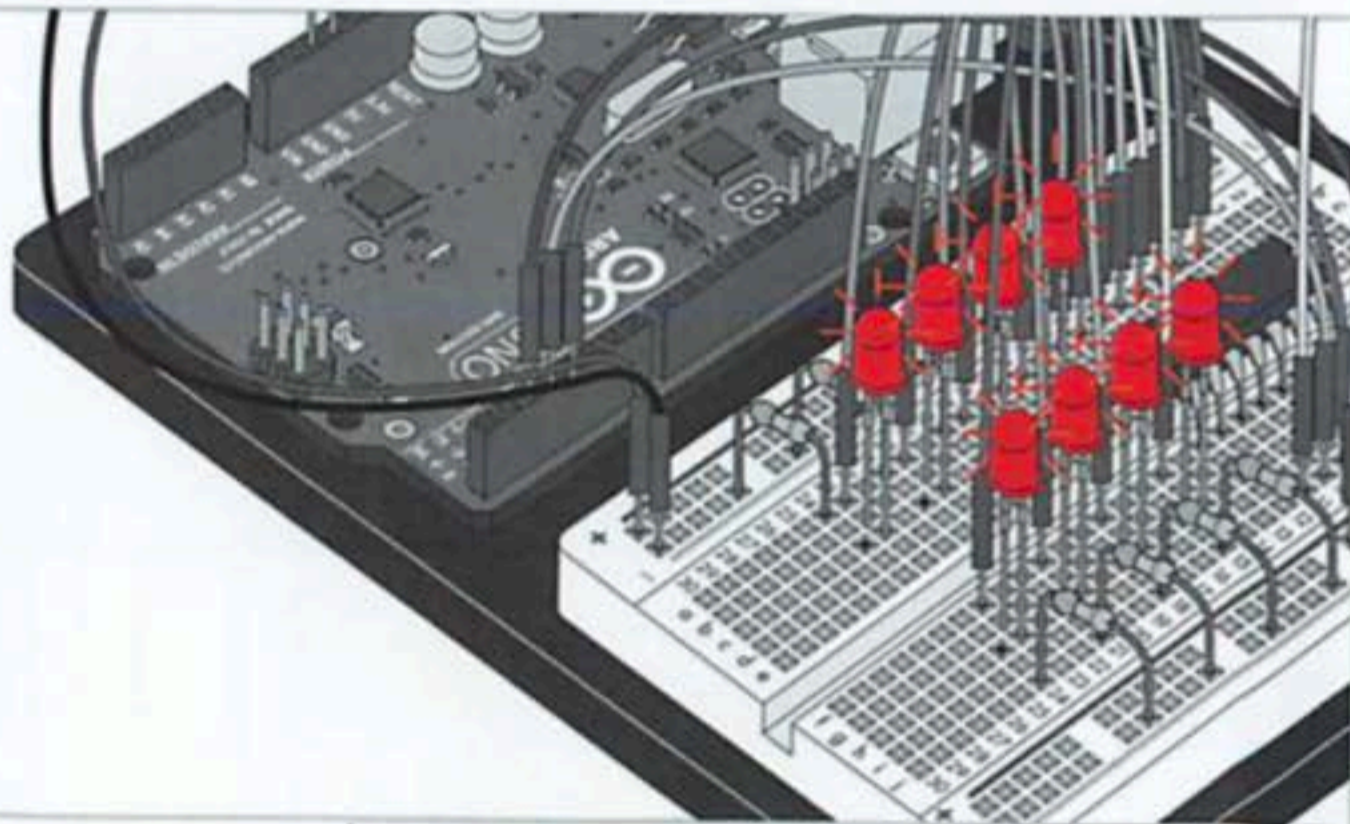


Bits are the smallest possible piece of memory in a computer; each one can store either a "1" or a "0". Larger numbers are stored as arrays of bits. Sometimes we want to manipulate these bits directly, for example now when we're sending eight bits to the shift register and we want to make them 1 or 0 to turn the LEDs on or off. The Arduino has several commands, such as bitWrite(), that make this easy to do.

```
bitWrite(data,desiredPin,desiredState);
```

What You Should See:

You should see the LEDs light up similarly to in circuit 4 (but this time, you're using a shift register). If they aren't, make sure you have assembled the circuit correctly and verified and uploaded the code to your board, or see the troubleshooting tips below.



Troubleshooting:

The Arduino's power LED goes out

This happened to us a couple of times, it happens when the chip is inserted backward. If you fix it quickly nothing will break.

Not Quite Working

Sorry to sound like a broken record but it is probably something as simple as a crossed wire.

Frustration

Shoot us an e-mail, this circuit is both simple and complex at the same time. We want to hear about problems you have so we can address them in future editions: techsupport@vilros.com

Real World Application:

Similar to circuit #4, a scrolling marquee display delivers a message with multiple LEDs. Essentially the same task the shift register achieves here in Circuit #12.

